

# FACTORYCAT

Industrial Cleaning Equipment

# GTR



29" - 34" Scrubbers



\*HD package pictured.

## A COMPLETE FAMILY OF INDUSTRIAL CLEANING EQUIPMENT



# KEY FEATURES

# INDUSTRIES



**Machine Control Panel** uses off-the-shelf toggle and marine duty switches featuring universal icons which simplifies training.



**Vacuum Muffler** allows machine to consistently achieve as low as 70 dBA while thoroughly drying the floor.



**Squeegee Adjustments made simple** tool-less maintenance of the squeegee blade.

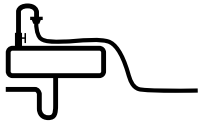

**Fill System** features a retractable hose for easy filling on standard sink-faucets and a stainless screen for bucket filling.



**Oversized Vacuum Screen Shut-Off** quickly arrests overflow issues to protect the Vacuum Motor.

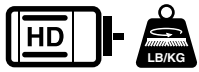

**High Performance motors and down pressure** provides an unmatched standard of cleaning.



\*HD package pictured.

- Fabrication Shops
- Machine Shops
- Aviation
- Beverage Distribution
- Warehouses
- Automotive Shops
- Food Packaging
- Sports Arenas



\*HD package pictured.

## TANK TIPS BACK FOR EASY ACCESS

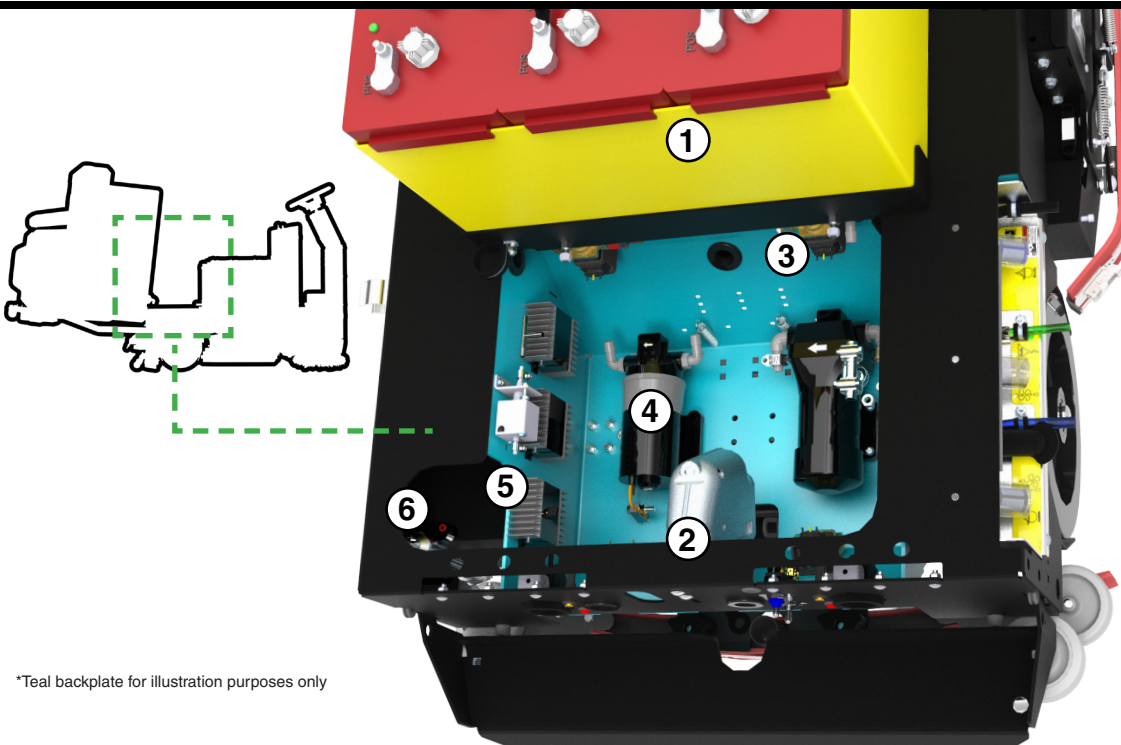

- ① Service Batteries
- ② Squeegee Actuator
- ③ Solution Valves
- ④ Pumps
- ⑤ ZER03 Generators
- ⑥ ZER03 Air Drier

\*Teal backplate for illustration purposes only

# VIEW INSIDE

Oversized Vacuum Screen    Drain Saver Basket    Solution Fill Points

Indicator Dash Lights

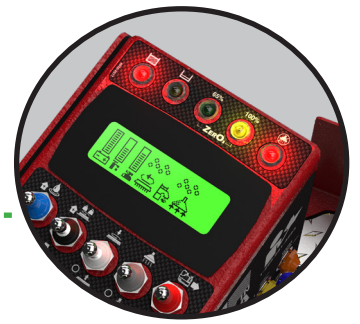

Adjustable Steering

Vacuum Protection System

Poly Battery Box With Drain

Back Up Light & Optional Rear Work Light



Optional Headlights



Heavy Duty Steel Frame & Adjustable Bumper

\*HD package pictured.

Service Cabinet

Heavy Duty Solid Tires

Optional Onboard Charger

Optional Sidebrooms

Tower Rollers

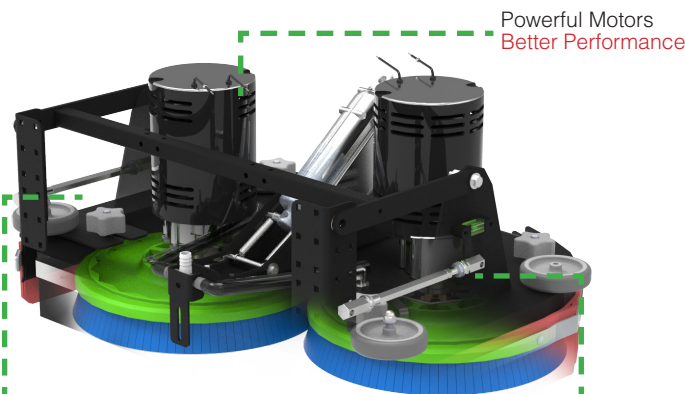

Thick Steel Design  
1/4" Thick for Durability

Coated Deck Design  
Corrosion Resistance

## Disk Benefits

- Brush / Pad Selection
- Lowest Maintenance Cost
- Gimballled Drivers Improves Cleaning On Irregular Floors
- Brushes Individually Driven For Unmatched Performance

\*HD package pictured.

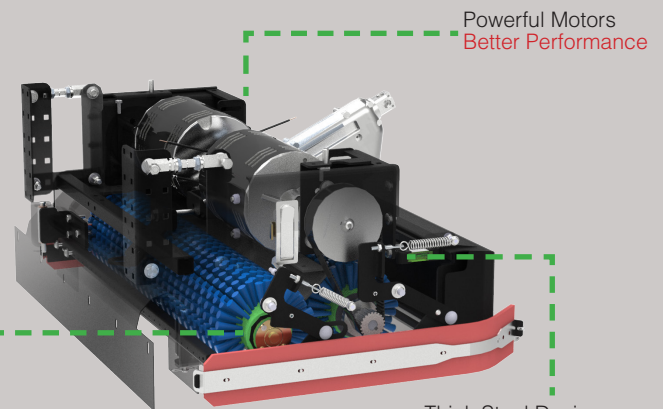

Oversized Brushes (6")  
Longer Life

Thick Steel Design  
1/4" Thick for Durability

## Cylindrical Benefits

- Eliminates Dust Mopping
- Scrub & Sweep Simultaneously
- Superior Expansion Joint Cleaning

\*HD package pictured.

# RECOVERY AND VAC BOX

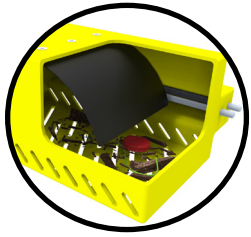

The Drain Saver Basket collects debris so it doesn't clog floor drains.

Water from rear squeegee travels through this hose into the recovery tank.

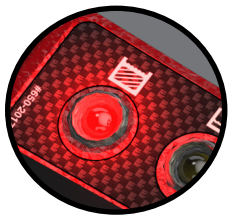

When the tank becomes nearly full a red indicator light in the dashboard turns on.

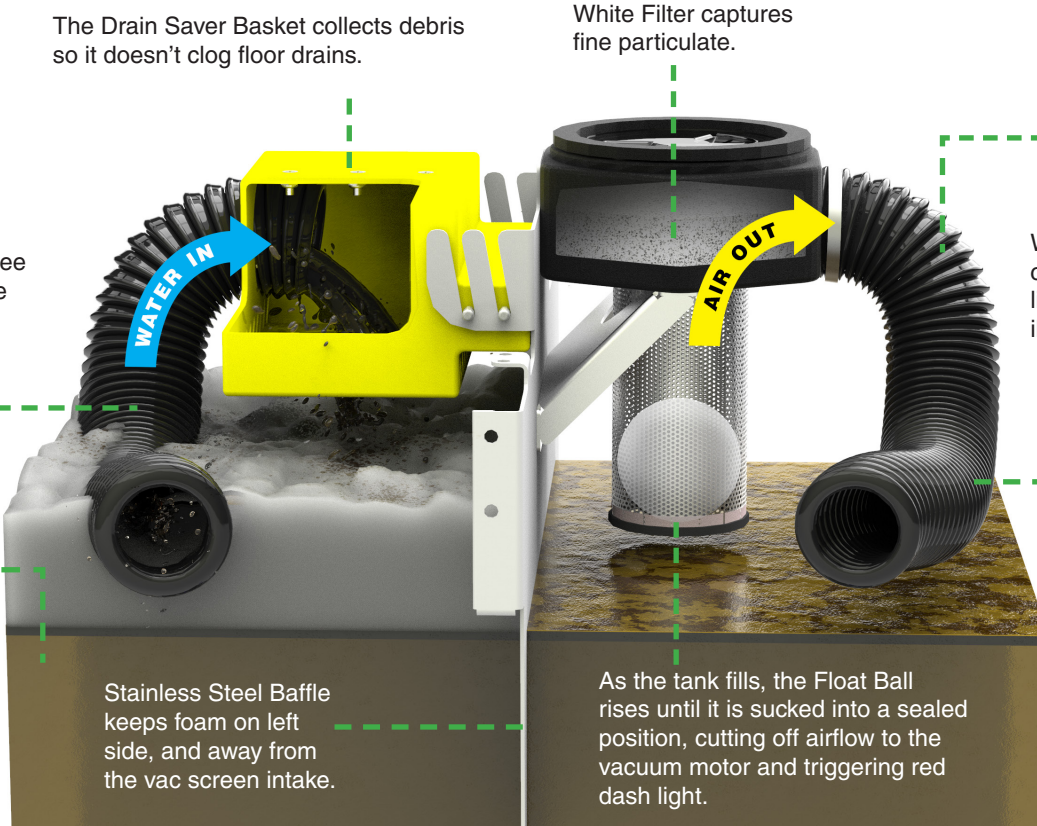

White Filter captures fine particulate.



When the squeegee clogs a red indicator light in the dashboard illuminates.

Airflow is drawn through this hose. Any water from this point will travel to the Yellow Vac Box.

Stainless Steel Baffle keeps foam on left side, and away from the vac screen intake.

As the tank fills, the Float Ball rises until it is sucked into a sealed position, cutting off airflow to the vacuum motor and triggering red dash light.

## Vac Box Unloader

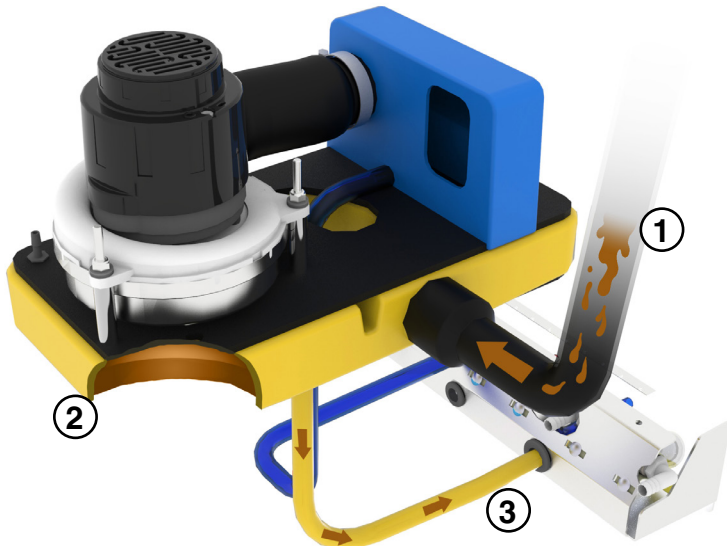

1. If dirty solution bypasses the Vacuum Filter Screen & White Filter, it will flow into the Yellow Vac Box.
2. The water stays in the Yellow Vac Box chamber due to vacuum pressure and only flows out when the vacuum turns off.
3. After shutting off the vacuum, any dirty water inside the Yellow Vac Box flows down to the Service Cabinet and out the unloader valve.

## Vacuum Discharge

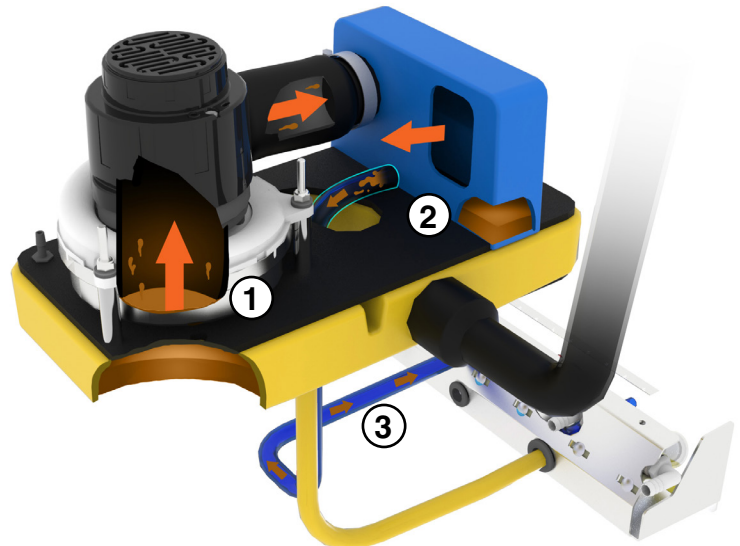

1. In the rare case the Yellow Vac Box overfills, water will pass through the motor.
2. Water passing through the Vacuum Motor exhausts in the Blue Reservoir where it will drain down to the Service Cabinet.
3. On the Service Cabinet, a clear bowl shows water has passed through the Vacuum Motor. There is an overflow hose so that extra water flows freely out the blue drain hose.

# SERVICE CABINET

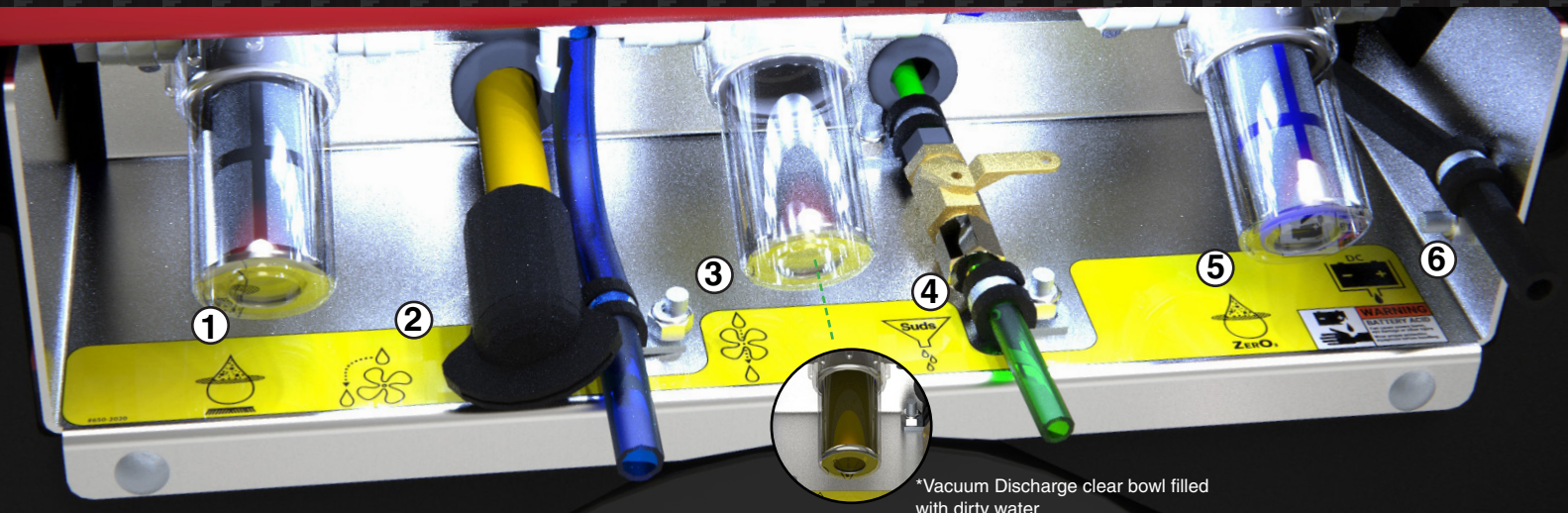

\*Vacuum Discharge clear bowl filled with dirty water.

- 1 SOLUTION FILTER:**



Standard Solution Feed Filter for scrubdeck.
- 2 VAC BOX UNLOADER:**



Unloader valve for the Yellow Vac Box. Water present in the Yellow Vac Box will drain when vacuum is off.
- 3 VACUUM DISCHARGE:**



Water passed through the Vacuum Motor will be visible in the reservoir and excess will flow from the blue hose. Indicates service required.
- 4 SUDS DRAIN:**



Drain detergent from Suds reservoir.
- 5 ZERO3 FILTER:**



Optional ZERO3 (O3+) Ozone System Solution Filter.
- 6 BATTERY DRAIN:**



Drain any fluid from Poly Battery Box.

# COMMON OPTIONS



**Spray Jet** allows operators to spray down hard to reach areas



**Overhead Guard** protects operator from falling debris



**Suds** - Universal soap proportioning system with two dilution levels



**ZERO3** - Chemical free solution created on-site and on-demand



**Side Doors** protect scrubdeck from impact damage



**Side Brooms** sweep up against walls and under racking

# CALL FOR A DEMONSTRATION



☎ **800-634-4060**  
 🌐 **(+001)-262-681-3583**  
 🌐 **www.factorycat.com**

Since 1986, our family owned company has been designing, building and supporting the best in floor maintenance equipment. Our **FACTORYCAT** brand services the world with unsurpassed industrial cleaning equipment, continually exceeding expectations and setting the industry bar that much higher.

We've built our reputation by providing the highest value machines and providing local support via 425 distributors in over 42 different countries.

## AUTHORIZED DISTRIBUTOR

### BODY CONSTRUCTION / DIMENSIONS

Tank Material:	Poly 3/8" (9.5 mm)
Chassis Construction:	3/16" (4.8 mm) & 1/8" (3.1 mm) Steel Powder Coated Steel
ST Front Wheel (Diameter x Width):	10" x 3" (25.4 x 7.6 cm) - Solid Black Hytrak
HD Front Wheel (Diameter x Width):	12" x 3" (30.5 x 7.6 cm) - Solid Black Hytrak
Rear Wheels (Diameter x Width):	(4x) 12" x 3" ([2x] 30.5 x 7.6 cm) - Solid Black
Size (L x W x H):	62" x 32" x 57" (157.5 x 81.3 x 144.8 cm)
ST Weight (w/o Batteries):	790 lbs (358.3 kg)
HD Weight (w/o Batteries):	914 lbs (414.6 kg)
ST Weight (w/ Batteries):	1,186 lbs (538.0 kg)
HD Weight (w/ Batteries):	1,436 lbs (651.4 kg)

### BRUSH / PAD SYSTEM

Disk Dimensions:	30" - (2x) 15" Ø (76.2 - [2x] 38.1 cm) 34" - (2x) 17" Ø (86.4 - [2x] 43.2 cm)
Disk Brush Speed:	350 rpm
Cylindrical Dimensions:	29" - (2x) 6" Ø x 27" (73.7 - [2x] 15.2 x 68.6 cm) 33" - (2x) 6" Ø x 31" (83.8 - [2x] 15.2 x 78.7 cm)
Cylindrical Brush Speed:	HD: 825 rpm / ST: 650 rpm
ST Motors (Disk & Cylindrical):	(2x) 0.75 hp / 350 rpm ([2x] 550 watts)
HD Motors (Disk & Cylindrical):	(2x) 1.5 hp / 350 rpm ([2x] 1,118.6 watts)
Brush Pressure Settings:	(5) with Auto Adjust
Brush Down Pressure:	Up to 225 lbs (102.1 kg) / 500 lbs (226.8 kg) Actuator Rating

### POWER SYSTEM

System Voltage:	36 VDC
ST Standard Battery:	245 ah WET
ST Optional Batteries:	250 ah AGM
HD Standard Battery:	310 ah WET
HD Optional Batteries:	360 ah WET / 335 ah AGM
Run Time:	Up to 5.0 Hours*
<small>*Run time is calculated based on HD Batteries, Down-pressure #1, typical Operator break periods, and Drain &amp; Refill times.</small>	
ST Charger:	120VAC / 60 Hz Input - 36VDC / 25 amp Output
HD Charger:	120VAC / 60 Hz Input - 36VDC / 36 amp Output

### DRIVE SYSTEM:

ST Power:	1.0hp - All Gear / Sealed (745 watts)
HD Power:	2.0hp - All Gear / Sealed (1491 watts)
Forward Speed:	0 - 320 ft/min / 0 - 3.6 mph (0 - 98 m/min / 0 - 6 km/h)
Scrubbing Speed:	0 - 256 ft/min / 0 - 2.9 mph (0 - 78 m/min / 0 - 5 km/h)
Reverse Speed:	0 - 230 ft/min / 0 - 2.6 mph (0 - 70 m/min / 0 - 4 km/h)

### SOLUTION / RECOVERY SYSTEMS:

Solution Tank Capacity:	46 Gallons (174.1 liters) - w/ Graduated Site Tube
Solution Flow / Filter:	0 - 0.7 GPM / Stainless Inline (0 - 2.6 LPM)
Recovery Tank Capacity:	49 Gallons (185.5 liters) - 1.5" diameter Drain Hose
Demisting Chamber:	2 Gallons (7.6 liters)
Drain Saver:	130 cubic inches (2,130.3 cm³)
Vacuum Power:	1.0 hp / 2 Stage / 6.6" (710 watts / 16.5 cm)
Vacuum Specs (Water Lift / Airflow):	73" / 96 cfm (185.4 cm / 2.7 cm³/m)
Squeegee:	Curved w/ 4-sided Rear Blade & Quick Change Latch 30D, 29C - 33" (83.8 cm) 34D, 33C - 36" (91.4 cm)

### GENERAL:

Cleaning Width:	30" & 34" - Disk (76.2 & 86.4 cm) 29" & 33" - Cylindrical (73.7 & 83.8 cm)
-----------------	---

Sound Levels: 70 dBA\*\*

\*\*Decibel levels per ISO 11201 as recommended by the American Association of Cleaning Equipment Manufacturers & OSHA

Productivity - Theoretical: Up to 46,875 sqft (4,354.8 sqm)\*\*

\*\*Productivity is based off of ISSA 2010 Cleaning Times

Productivity - Practical: Up to 21,661 sqft (2,012.4 sqm)\*\*

\*\*Productivity is based off of ISSA 2010 Cleaning Times



**Manufactured By**  
 R.P.S. Corporation  
 1711 South Street  
 Racine, Wisconsin 53404 (USA)  
 Phone: (800) 634-4060  
 International: (+001) 262-681-3583  
 www.factorycat.com