

# FACTORYCAT®

# PILOT-HD

## Operating Instructions (EN)

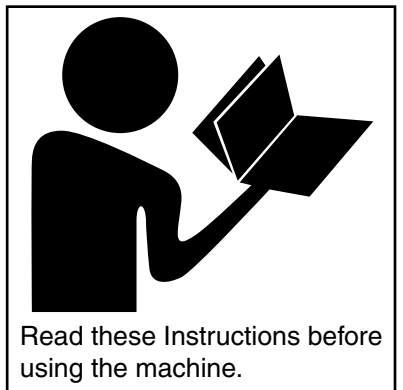
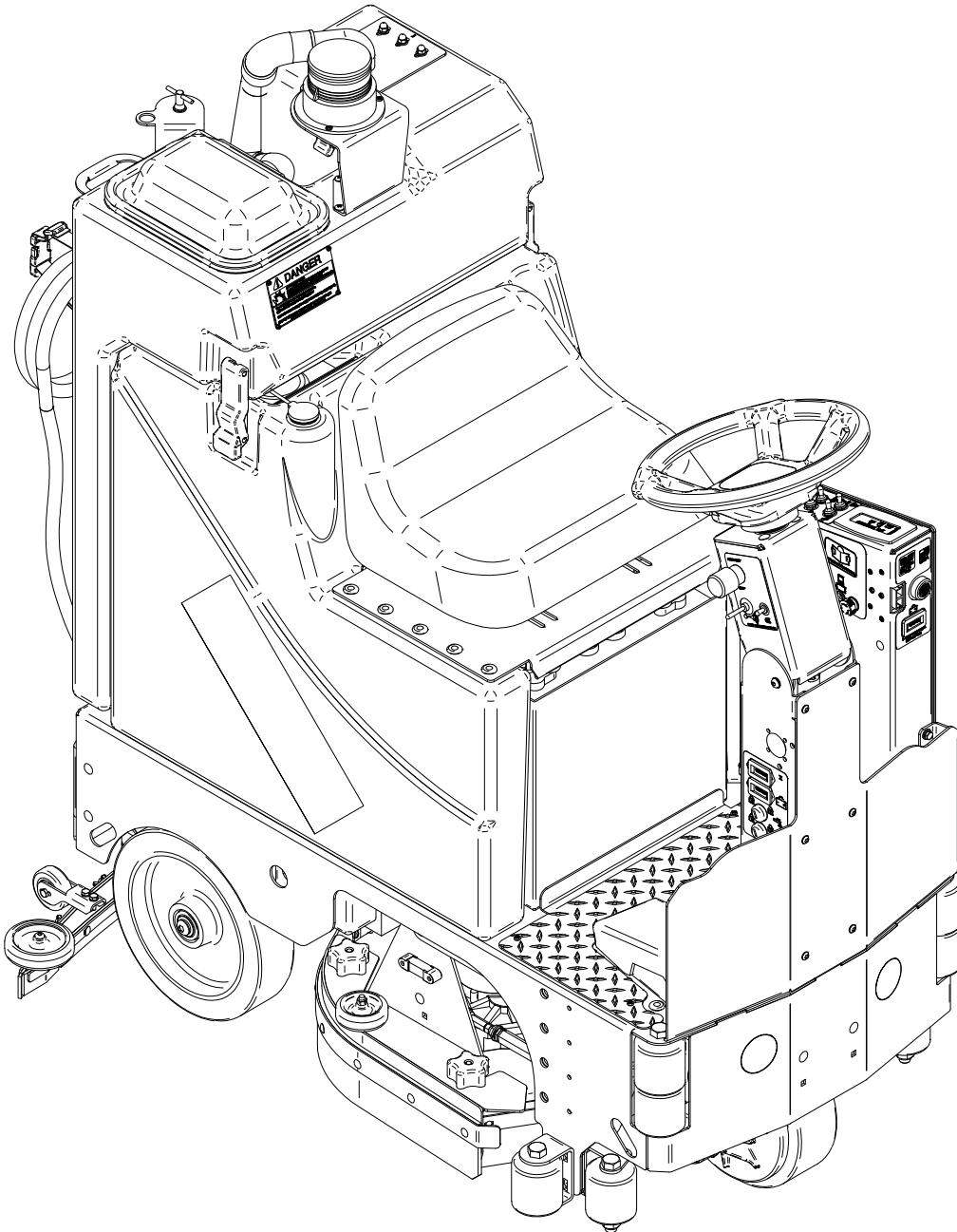

www.factorycat.com  
1711 South Street  
Racine, WI 53404 (USA)  
(800) 634-4060 | (+001) 262-681-3583  
© 2016 RPS Corporation

Scan With Phone for more Information



VERSION 16.224  
FC-PILOT-HD-OP-EN

## INTRODUCTION

This manual is furnished with each new machine. This manual will allow the Operator to get the best performance out of your RPS manufactured Scrubber-Drier, Sweeper, Burnisher, or Orbital Scrubber. Read this manual thoroughly before operating or servicing the machine.

This machine will provide excellent performance, but the best results will be obtained at the most minimum costs if:

- The machine is regularly maintained - per the Authorized Local Distributor.
- The machine is operated with reasonable care and caution.
- The machine is maintained with manufacturer supplied parts.

## LOCATE SERIAL NUMBER



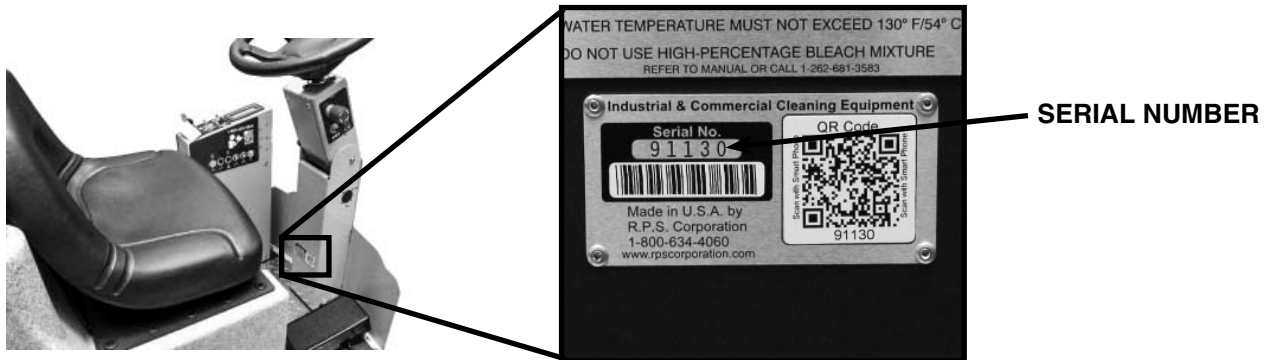



















The serial number of your machine is located on the lower half of the control panel of the machine.



AS OUR POLICY IS ONE OF CONSTANT IMPROVEMENT - ALL INFORMATION AND SPECIFICATIONS ARE SUBJECT TO CHANGE WITHOUT NOTICE.

# TABLE OF CONTENTS



	Introduction.....	2
	Locate Serial Number.....	2
	Table Of Contents.....	3
	Safety Messages.....	4
	Safety Labels.....	6
	LCD Screen.....	7
	Operation Controls.....	8
	Optional Controls.....	9
	Battery Setup.....	10
	Remove Squeegee.....	11
	Adjust Squeegee.....	12
	Remove From Battery Charger.....	13
	Transportation - Forward.....	14
	Transportation - Reverse.....	15
	Fill Solution Tank.....	16
	Operation - Scrubbing.....	17
	Draining Recovery Tank.....	18
	Draining Solution Tank.....	19
	Flushing Recovery Tank.....	20
	Clean Drain Saver.....	21
	Clean Cylindrical Hopper.....	22
	Clean Vac Box System.....	23
	Remove Disk Brushes.....	24
	Remove Cylindrical Brushes.....	25
	Charge Batteries.....	26
	Battery Chargers.....	27
	Common Wear Parts.....	28
	Round Disk Brushes:.....	28
	Round Disk Pads:.....	28
	Cylindrical Brushes:.....	28
	Squeegee Blade Kits & Complete Squeegee Assemblies:.....	28



## SAFETY MESSAGES

You will see four kinds of safety reminders in this manual:

### **DANGER**

DANGER indicates a hazardous situation which, if not avoided, will result in death or serious injury.

### **CAUTION**

CAUTION indicates a potentially hazardous situation which, if not avoided, could result in minor or moderate injury or damage to this machine or nearby objects. CAUTION also can be used to alert against unsafe practices.

### **WARNING**

WARNING indicates a potentially hazardous situation which, if not avoided, could result in death or serious injury.

### **NOTICE**

NOTICE indicates information considered important, but not hazard-related. This safety message may be related to property damage or warranty warnings.

Your safety, and that of others, is very important. Operating this machine safely is an important responsibility.

### **DO NOT OPERATE THIS MACHINE:**

- Unless you are trained and authorized to do so by your RPS Authorized Local Distributor
- Unless you have read and understood this Operator's Manual
- On surfaces with greater than a 2% grade unless this machine is equipped with a functional parking brake
- On surfaces with greater than an 8% grade at any time
- On Loading Docks

### **WHEN OPERATING THIS MACHINE:**

- Remove loose objects from the floor that could be projected from the rotating Brushes
- Keep your hands and feet away from the rotating Brushes
- Do not operate this machine where flammable liquids, vapors, or dust are present
- Use caution when maneuvering

### **BEFORE LEAVING THE MACHINE:**

- Drain "clean" Solution & "dirty" Recovery solution into APPROVED drains
- Park the machine on a level surface
- Turn the machine off & remove key

### **BEFORE SERVICING THE MACHINE:**

- Disconnect the Batteries

### **DANGER**

Explosive hydrogen gas forms when Batteries are charging. An open flame or spark can cause this gas to explode. Serious personal injury or property damage could occur. Only charge the Batteries in this machine in a well ventilated area.

### **DANGER**

Flammable materials can cause an explosion or fire. Do not use flammable materials in Tank or pick up.

## **! WARNING**

The Batteries in this machine produce hazardous voltage which can cause electrical shock, burns and/or electrocution. Always disconnect Batteries before servicing this machine.

## **! WARNING**

When climbing or descending ramps, always drive machine forward. To avoid overturning the machine, Do not back down ramps. Do not drive across inclines. Do not turn while ascending or descending ramps. Overturning the machine can cause serious injury or death.

## **! WARNING**

Do not use water that exceeds 135°F / 57°C. If water is above said temperature, this will void the Tank Warranty.

## **! WARNING**

Do not park this machine on ramps or slopes. Always park this machine on a level, hard surface. Do not operate this machine outdoors or on uneven surfaces.

## **! WARNING**

The Batteries in this machine contain sulfuric acid, which causes burns to skin. If battery acid contacts clothing or skin, rinse the effected area with cold water immediately. If battery acid gets on your face or in your eyes, flush the area immediately with cold water and seek medical attention.

## **! WARNING**

To avoid electrical shock, do not operate this machine over electrical floor outlets.

## **! CAUTION**

To avoid damage to this machine, use only cleaning solutions and replacement parts recommended by the manufacturer.

## **! CAUTION**

Do not operate this machine if any parts have been damaged or removed.

## **! WARNING**

Dress safely. Do not wear rings or metal wrist watches when servicing this machine, as they can cause an electrical short circuit which can cause serious burns.

## **! WARNING**

Do not remove, paint over or destroy warning decals. If warning decals become damaged, call 1-262-681-3583 for free replacements.

## **! WARNING**

Dress safely. Do not wear a neck tie, scarf, or any loose or dangling clothing while operating this machine. Loose or dangling clothing or neck-wear can tangle in rotating parts, causing serious injury or death.

## **! WARNING**

Always turn off this machine before leaving it unattended. Do not allow untrained persons to operate this machine.

## **! WARNING**

NO RIDERS. Do not carry passengers on this machine. Do not use this machine as a stepladder or work platform.

## **! WARNING**

Understand the dynamic braking system before you operate the machine on ramps. Machine may coast.

## **! WARNING**

Before you service a Battery, always wear face protection, protective gloves and protective clothing. Battery acid or battery explosion can cause serious injuries.

## **! CAUTION**

Always use the automatic battery charger provided by the manufacturer of this machine to charge the Batteries of this machine. It is designed to charge the Batteries at the appropriate rate. If you must use a different charger, disconnect the Batteries before charging to avoid damage to the electronic speed controller.

## **! CAUTION**

To avoid damage to the electronic control components of this machine, Do not store this machine outdoors. Do not pressure wash this machine.



## SAFETY LABELS

Read and obey all Safety Labels on your PILOT-HD Floor Scrubber. If you have questions about these labels, ask your supervisor.

These images indicate where on the PILOT-HD Safety Labels are located. If ever the labels become illegible, worn off, or torn, promptly report it to your supervisor and replace it.



**TANK LABEL**  
PART #: 5-728

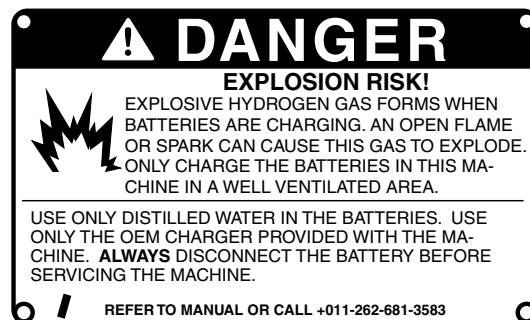

**BATTERY CHARGING LABEL**  
PART #: 253-7280

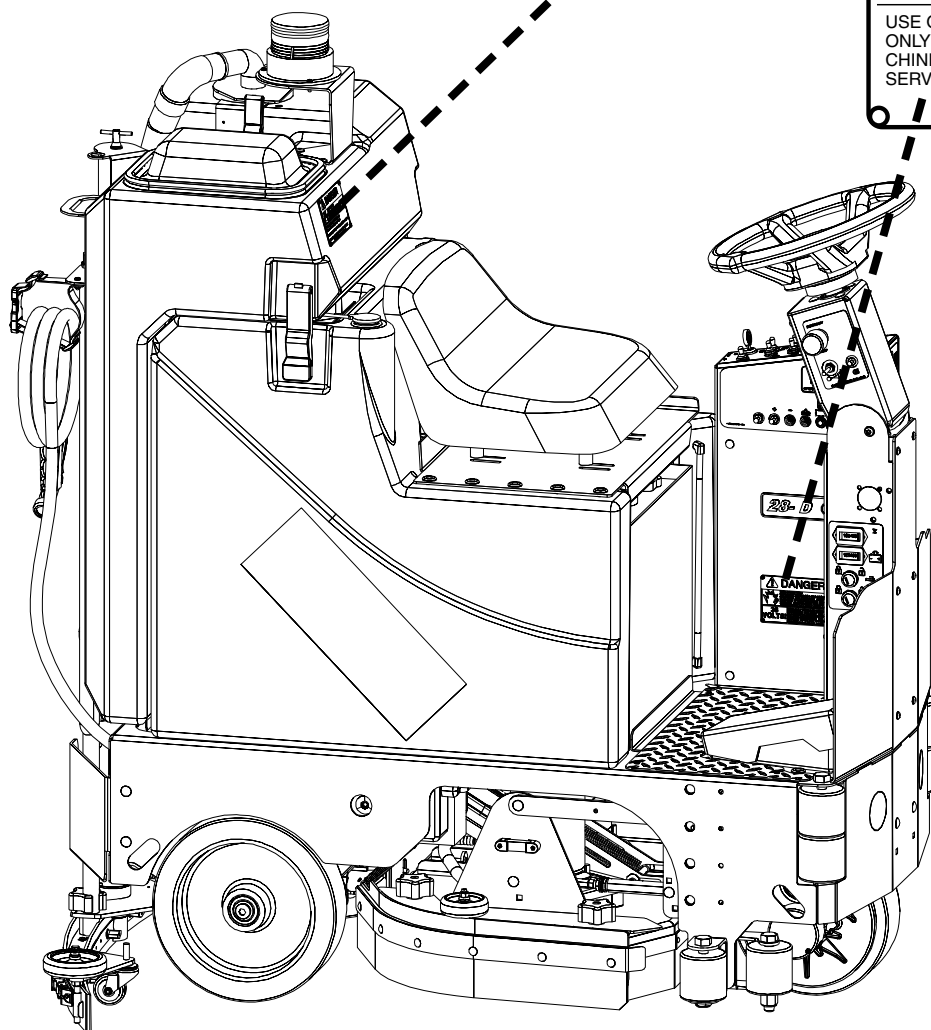

## LCD SCREEN



SCREEN #1 (OPERATOR)

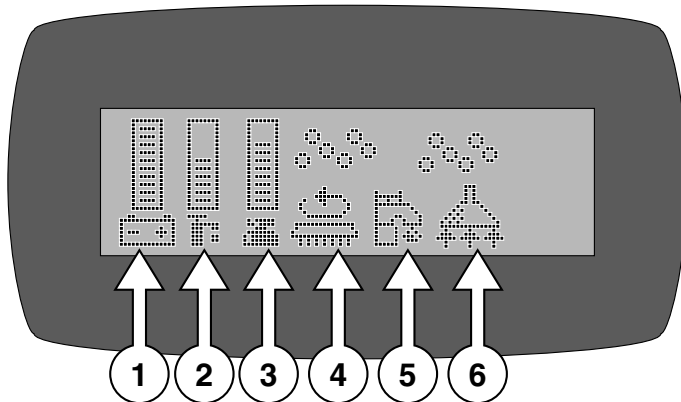

SCREEN #2 (MAINTENANCE)

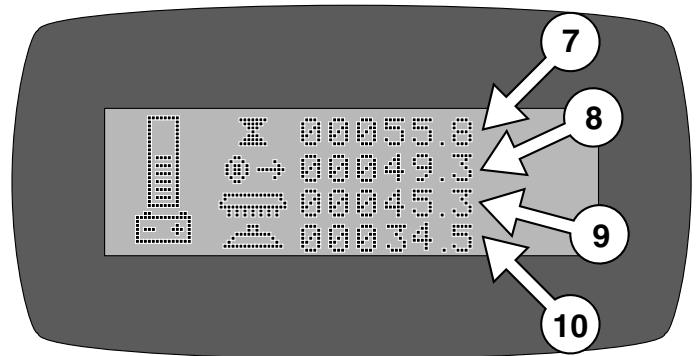

SCREEN #3 (WITH ERROR CODE)

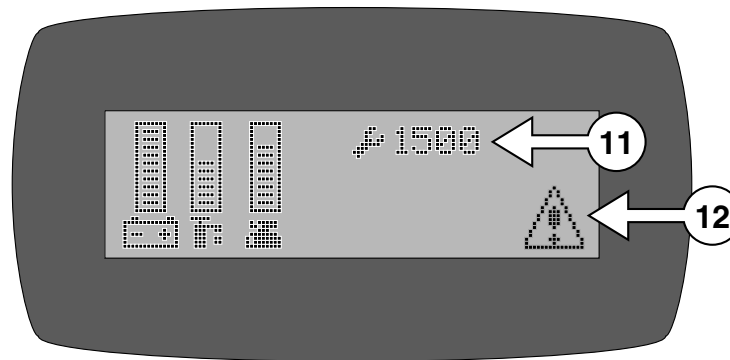

**\*\* USE GREEN MENU SELECTION BUTTON ON CONTROL PANEL TO CHANGE SCREENS \*\***

1. **BATTERY LEVEL INDICATOR** - Indicates the energy level remaining in the Batteries (*Shown on all menu displays*)
2. **SOLUTION OUTPUT INDICATOR** - Indicates the gallons per minute (*GPM*) 0 - 1.0
3. **SCRUBDECK DOWN PRESSURE INDICATOR** - Sets the down pressure on the Brushes / Pads
4. **SCRUB MOTORS ON** - Indicates the Brush Motors are in operation
5. **SOLUTION ON** - Indicates the solution flow is *ON*
6. **VACUUM ON** - Indicates the Vacuum is *ON*
7. **KEY SWITCH HOUR METER** - Indicates total hours the machine has had keyswitch *ON*
8. **TRANSPORT HOUR METER** - Indicates total hours the drive system has been in operation
9. **SCRUB BRUSH HOUR METER** - Indicates total hours the brush motors have been in operation
10. **VACUUM HOUR METER** - Indicates total hours the vacuum motor has been used
11. **DIAGNOSTIC CODE** - Displays diagnostic code which helps troubleshoot issues
12. **ERROR WARNING SYMBOL** - Indicates when there has been a diagnostic code error



# OPERATION CONTROLS

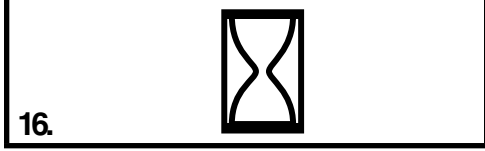
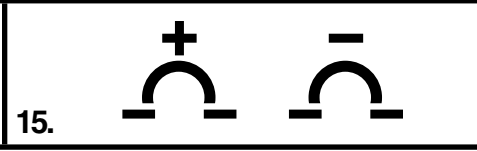
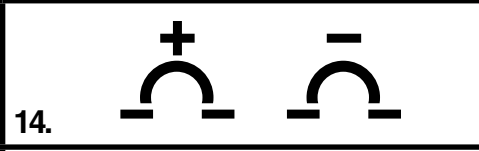
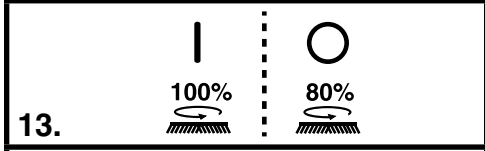
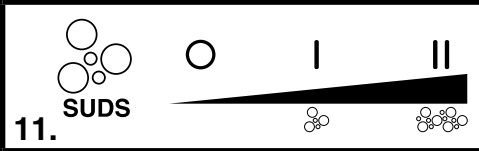
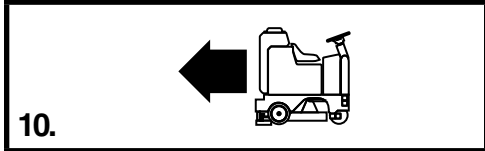
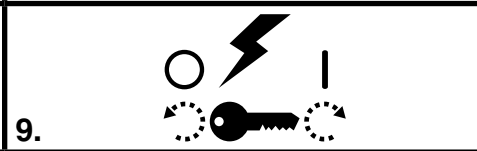
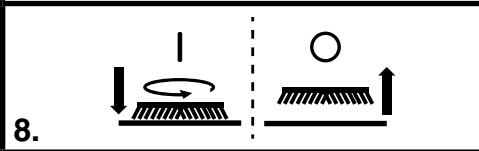
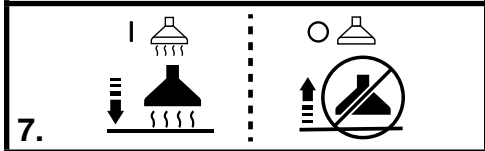
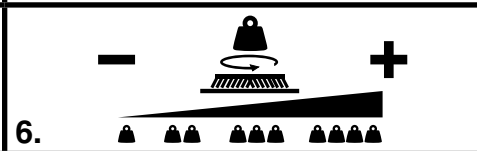
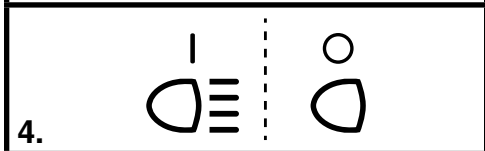
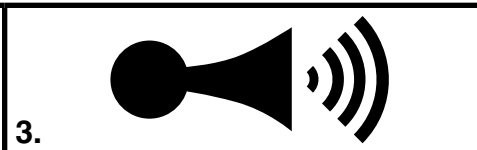
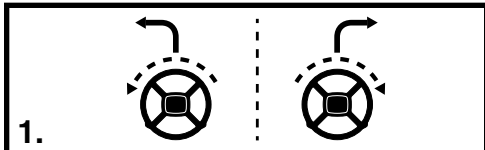
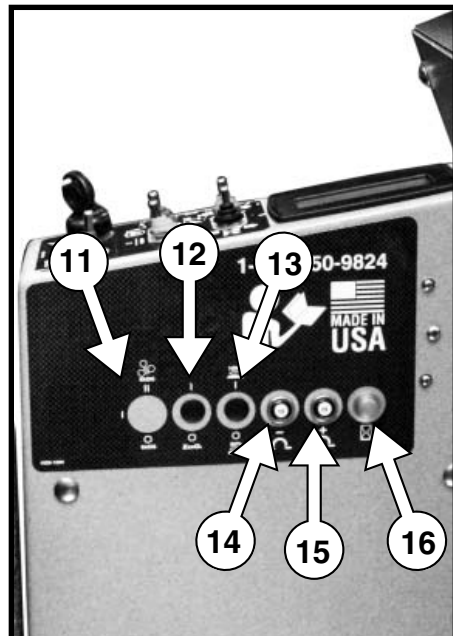
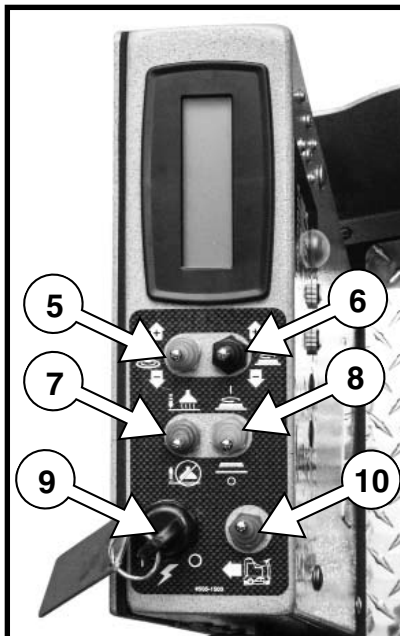
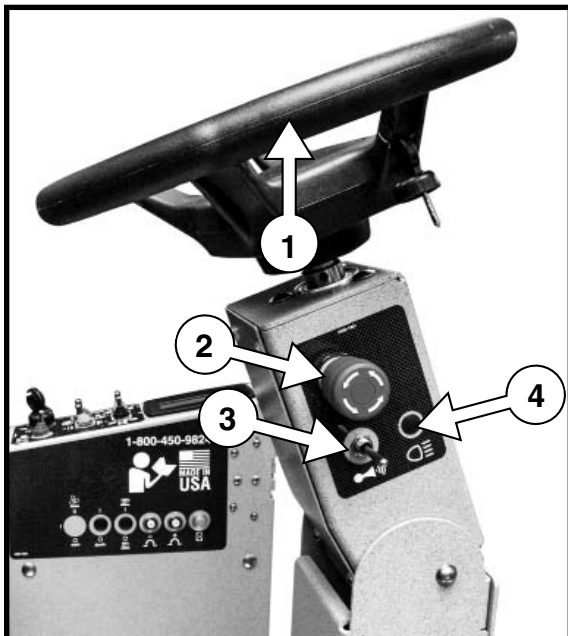



# OPTIONAL CONTROLS

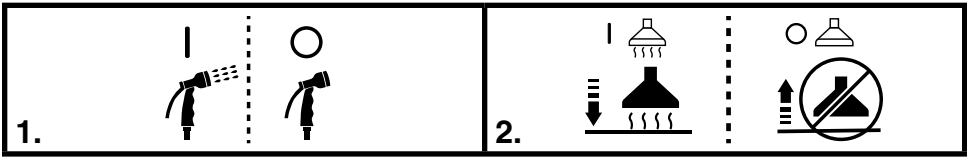
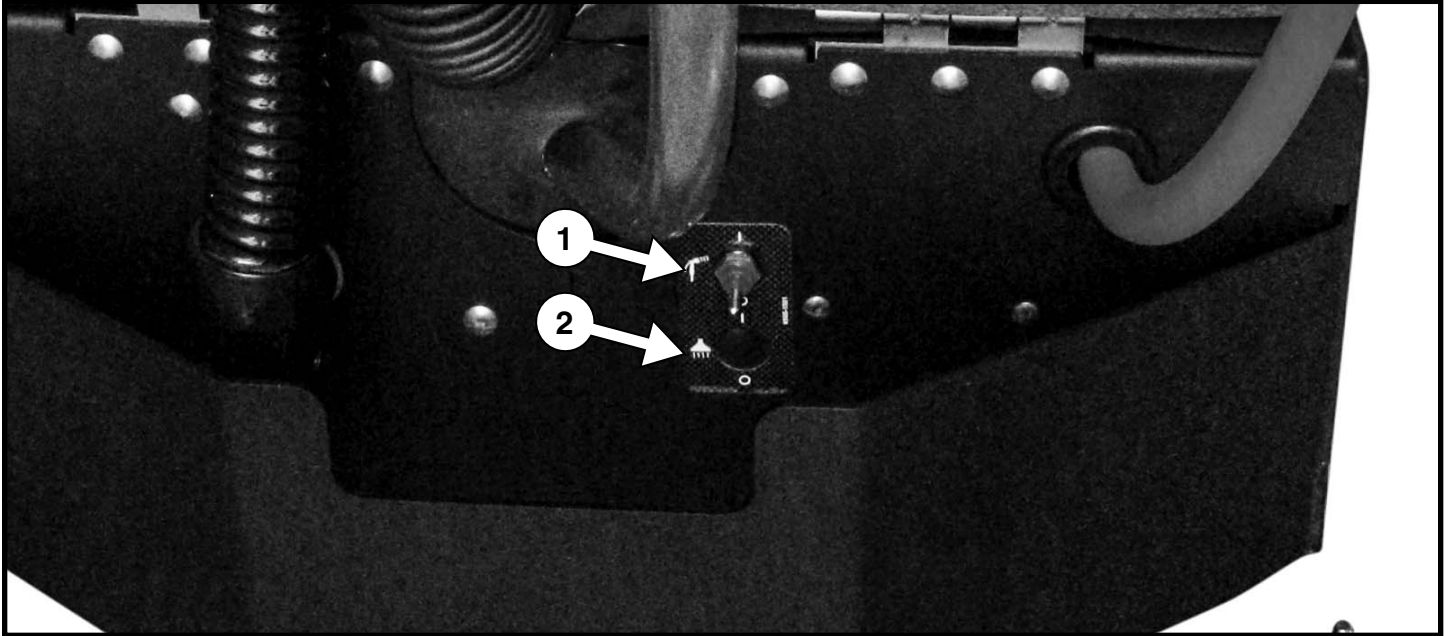
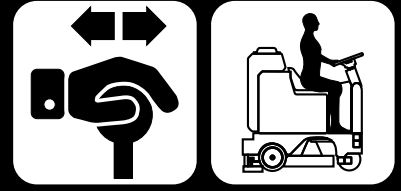

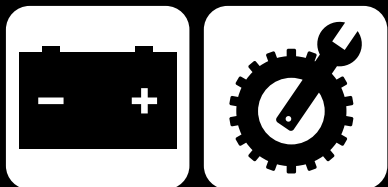

## BATTERY SETUP

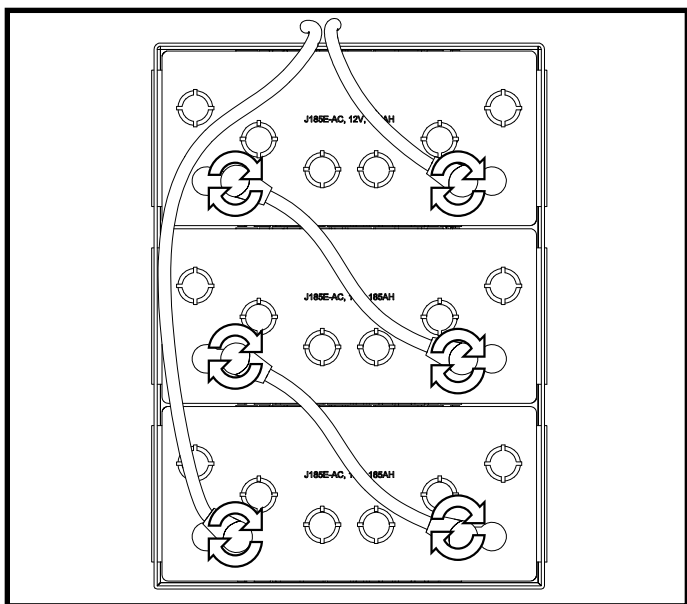
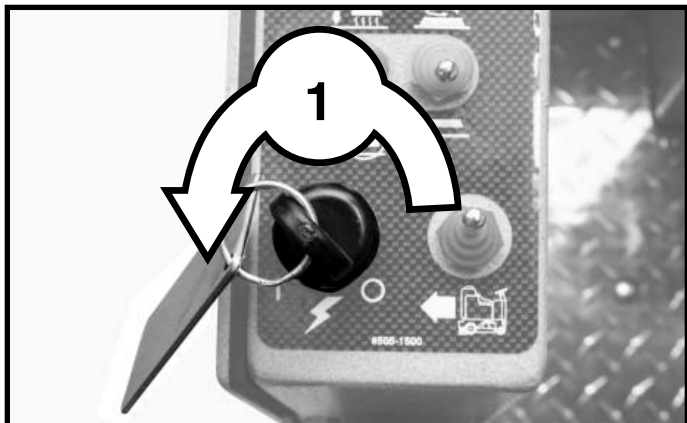

**36 VOLTS**

### NOTICE

Batteries are a possible environmental hazard. Consult your Battery supplier for safe disposal methods.

### NOTICE

Orientation of Batteries is critical for cables to reach. Ensure proper torque values when installing batteries. *(Between 8 - 12 ft/lbs)*

# REMOVE SQUEEGEE

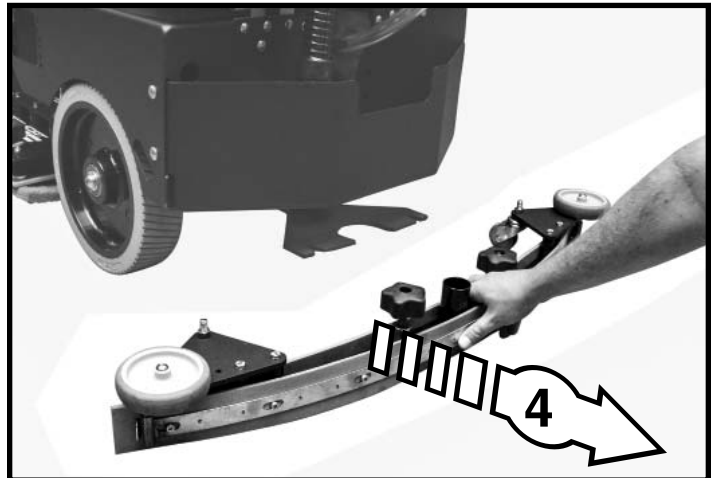
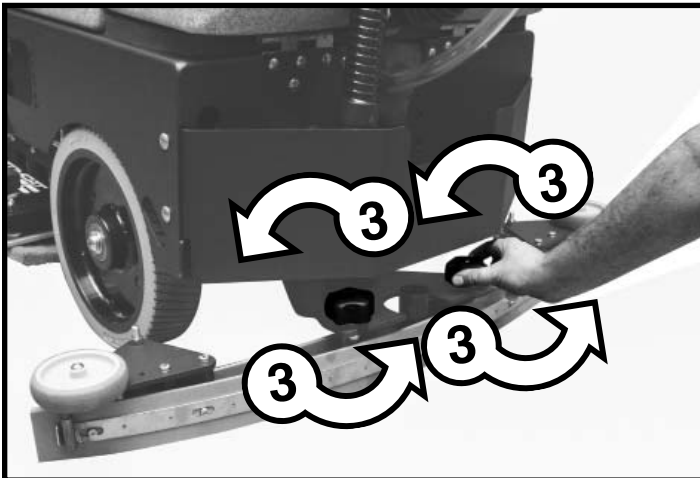
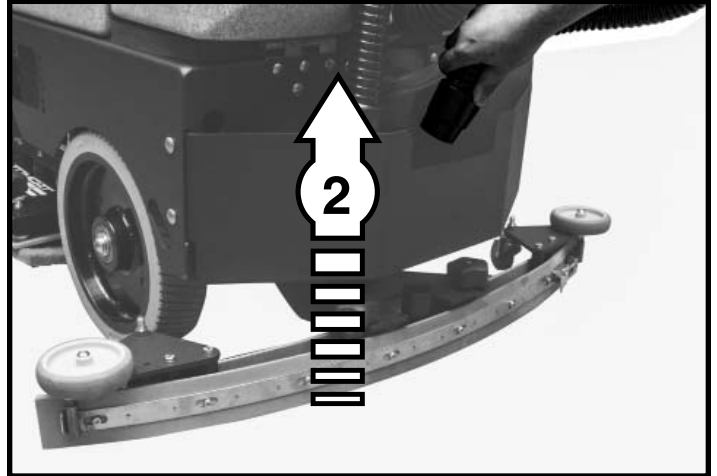
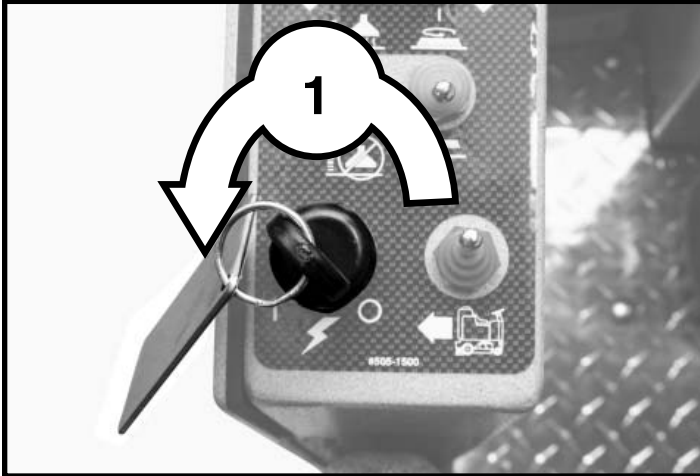

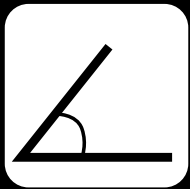

# ADJUST SQUEEGEE

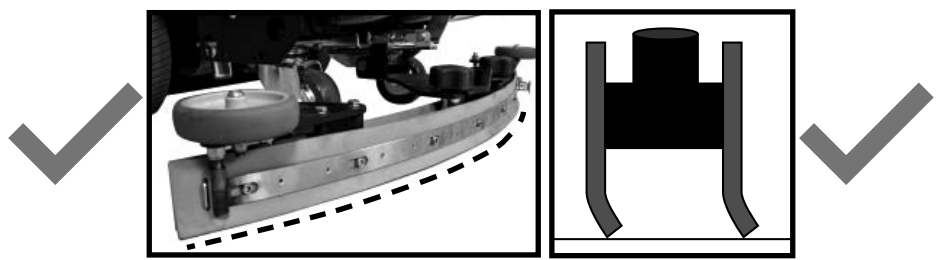
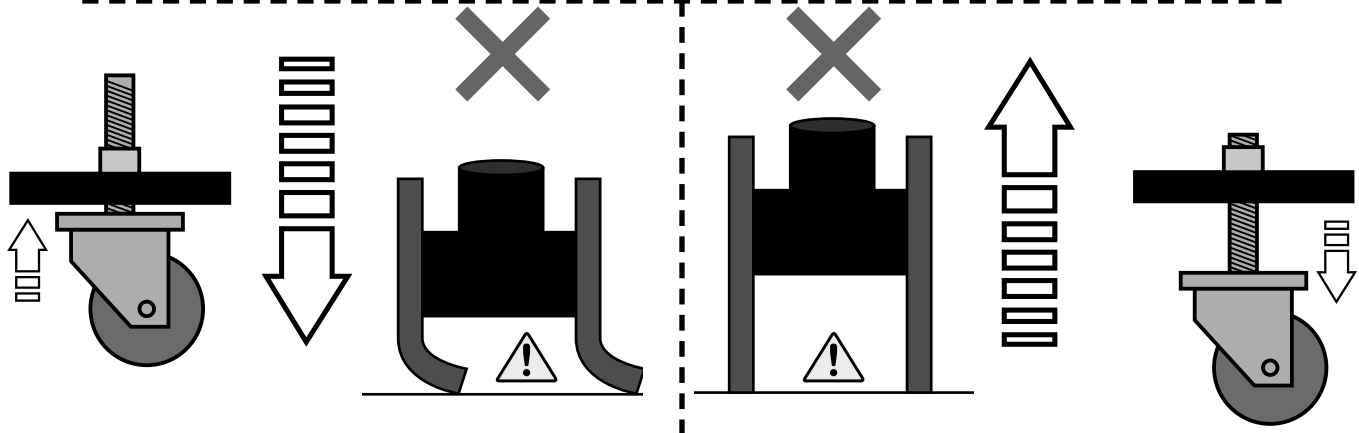
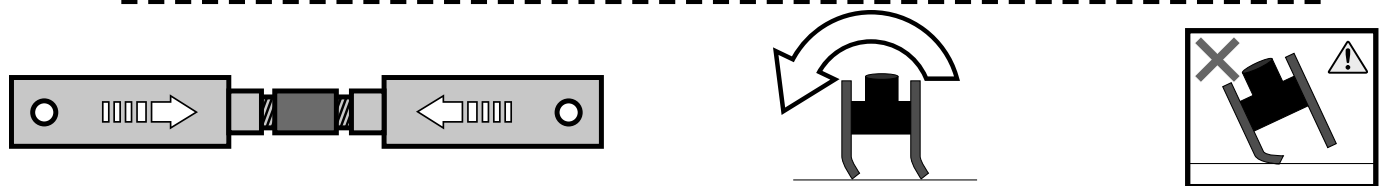
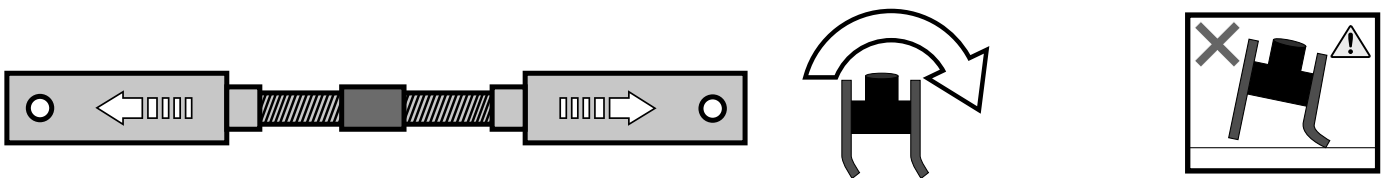
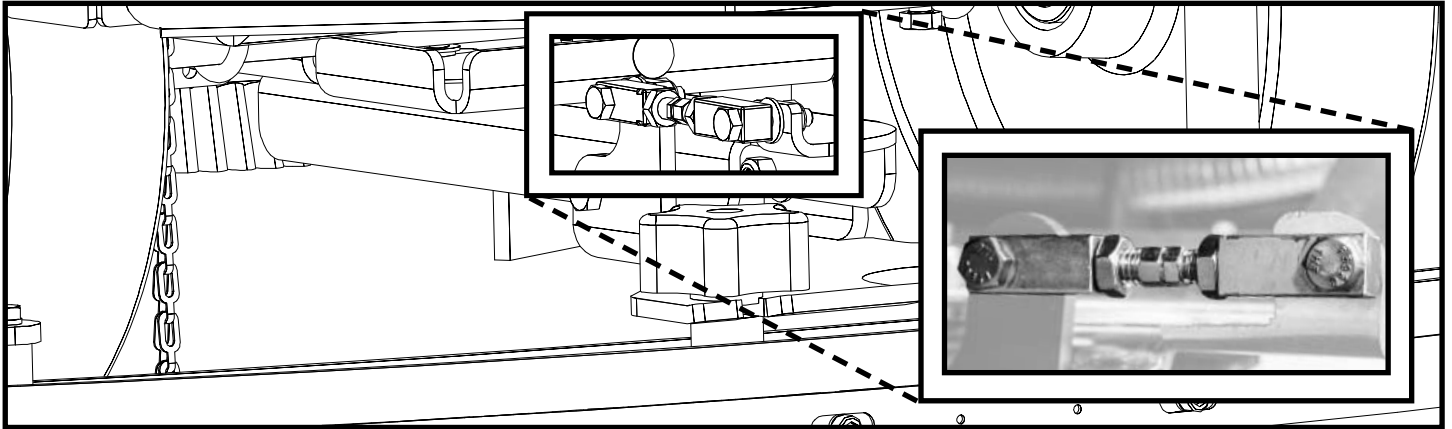

**REMOVE FROM BATTERY CHARGER**

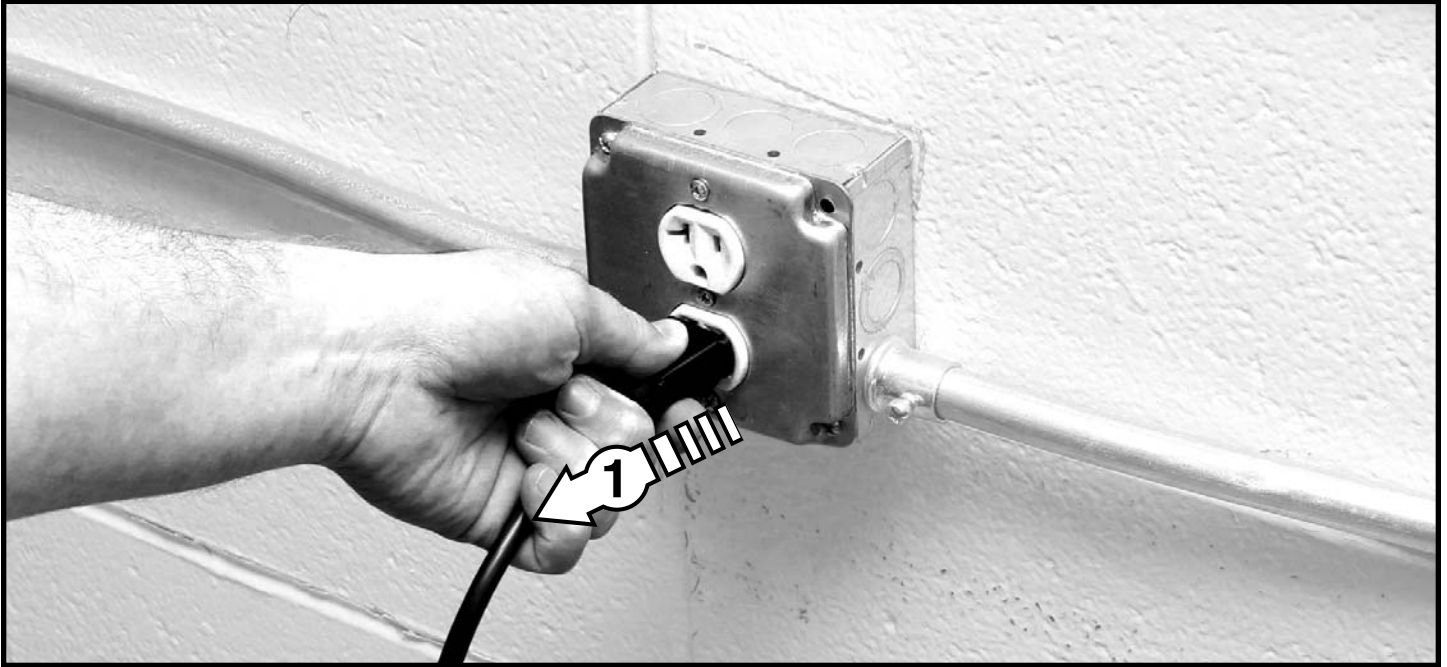
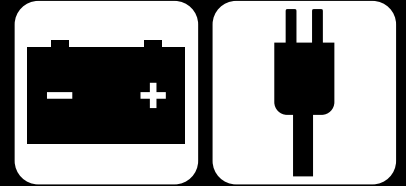

Please refer to OEM Charger Operating Instructions for more information.

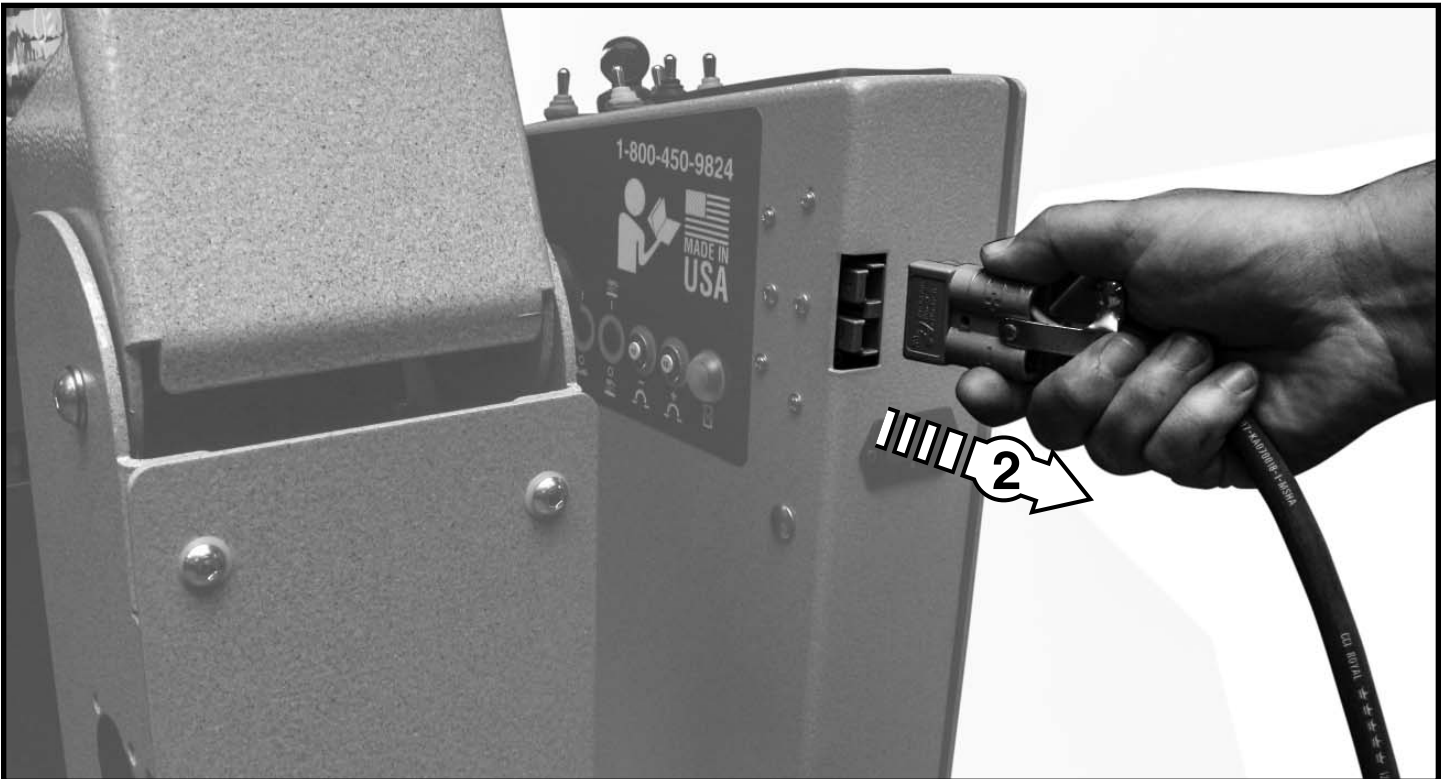



TRANSPORTATION - FORWARD

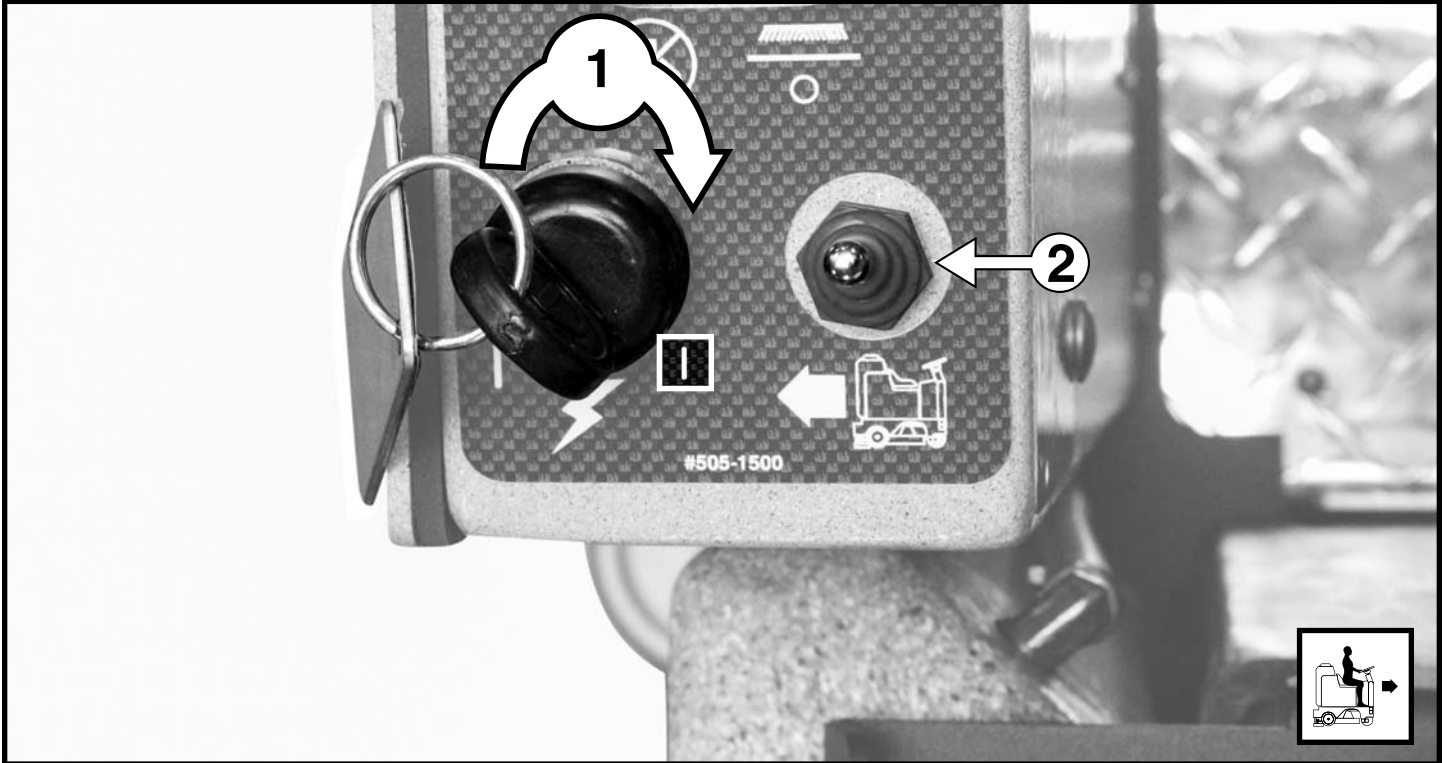

TRANSPORTATION - REVERSE

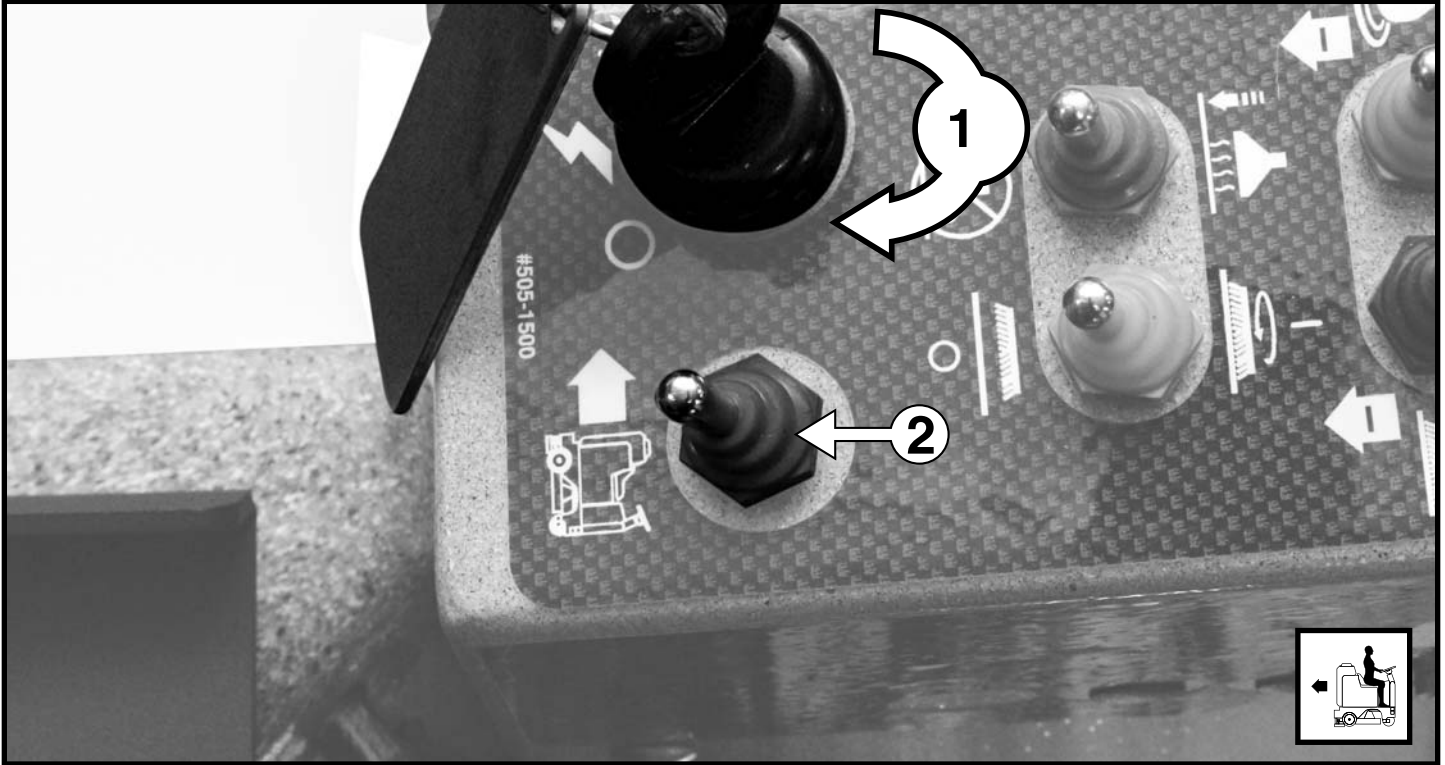

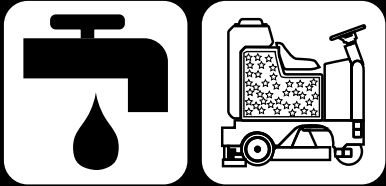

## FILL SOLUTION TANK

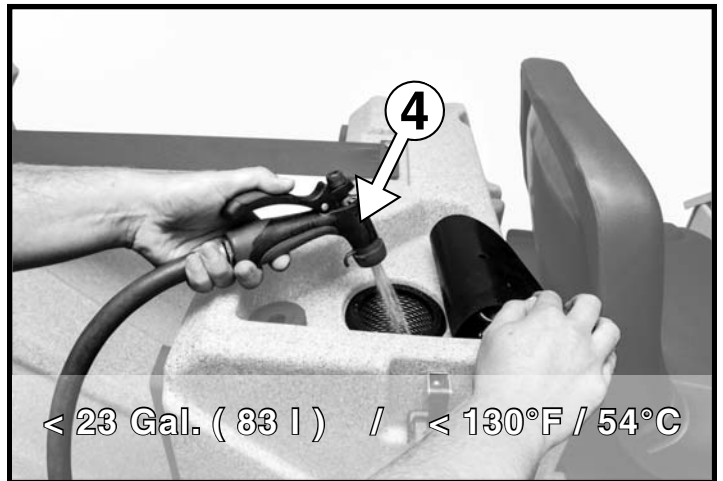
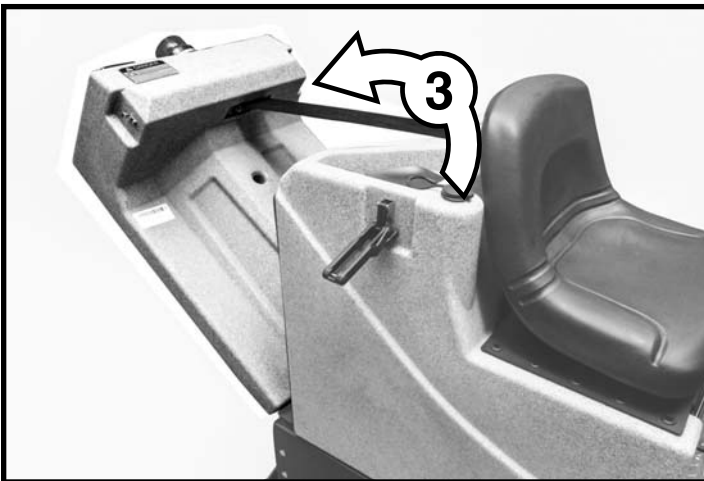
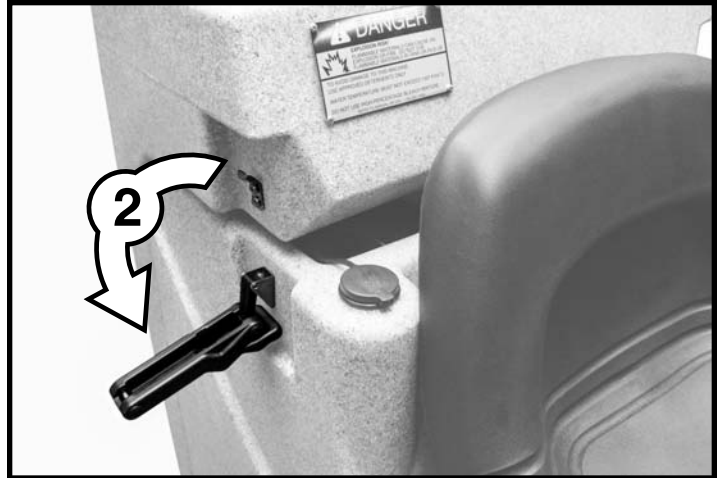

### **⚠ DANGER**

EXPLOSION RISK! Flammable materials can cause an explosion or fire. Do NOT use flammable materials in Tank or pick up.

### **⚠ CAUTION**

#### TO AVOID DAMAGE TO THIS MACHINE:

- Use APPROVED detergents only
- Water temperature must not exceed 130°F/54°C
- Do NOT use high-percentage Bleach mixture

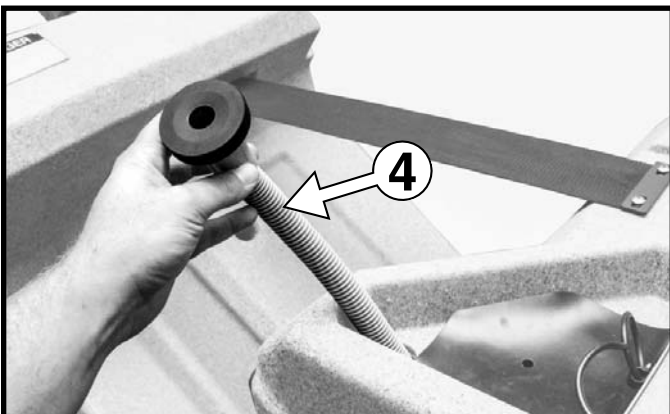



# OPERATION - SCRUBBING

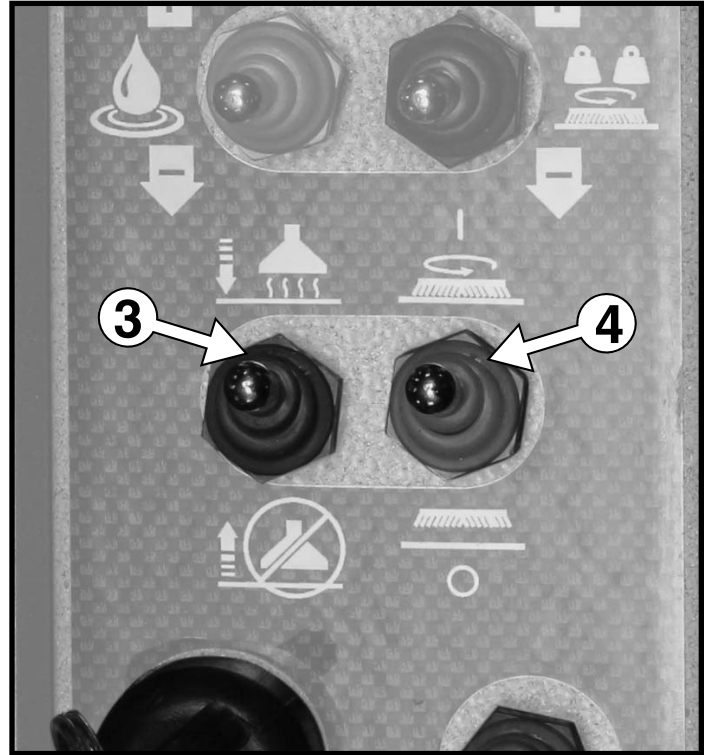
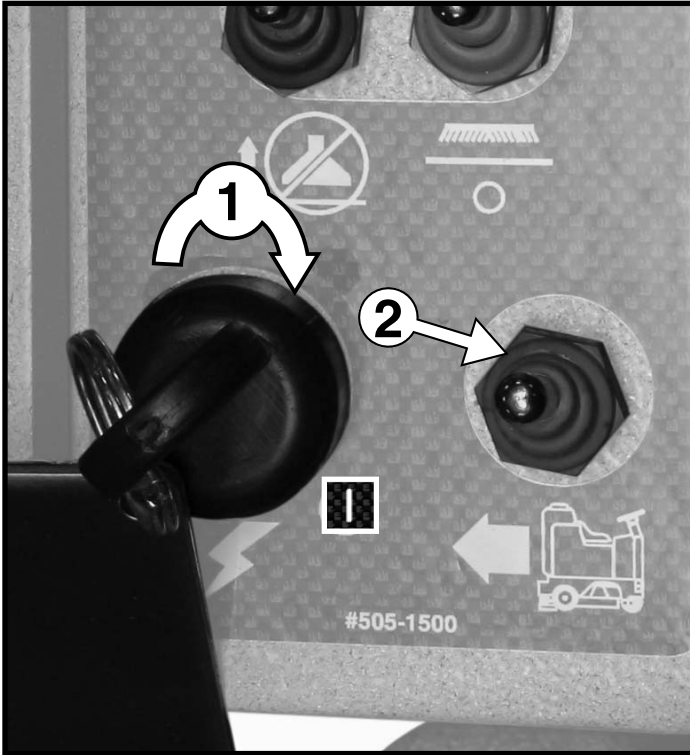
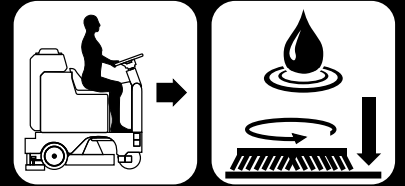



# DRAINING RECOVERY TANK

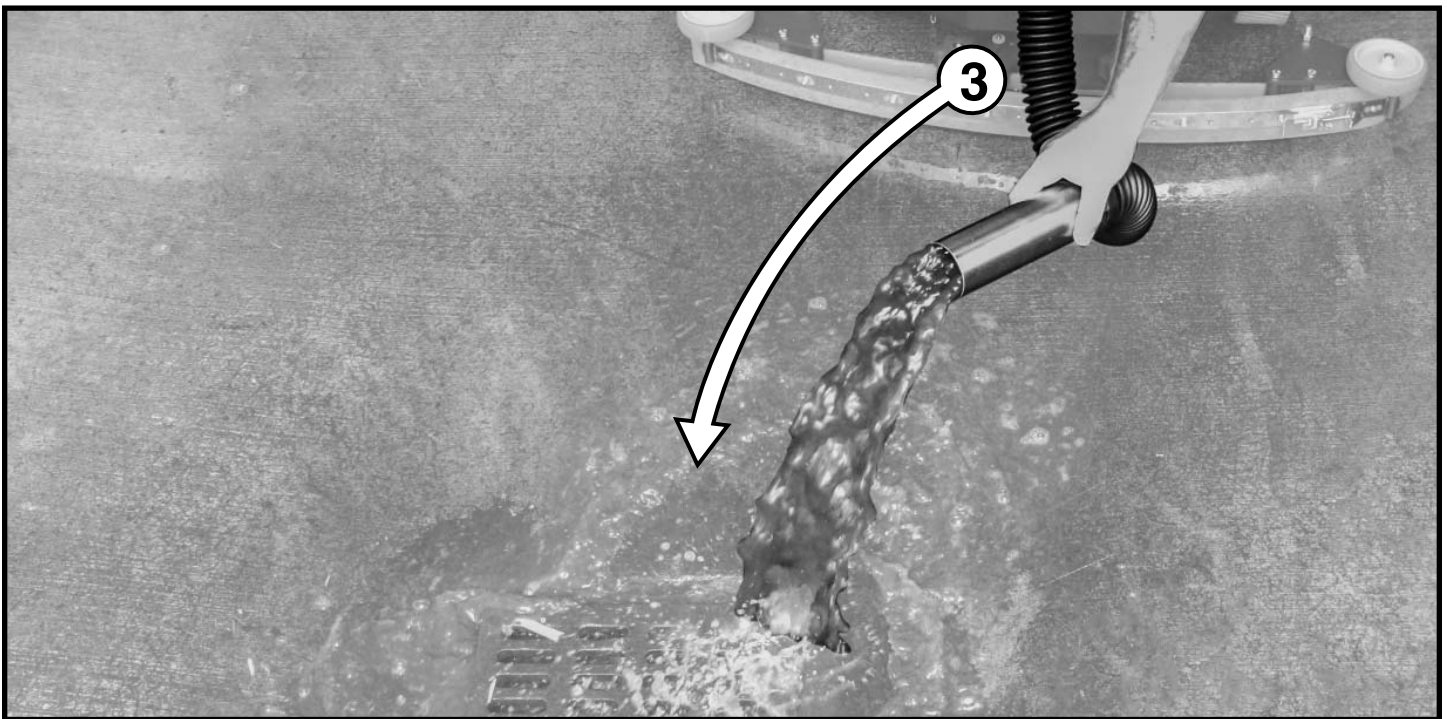
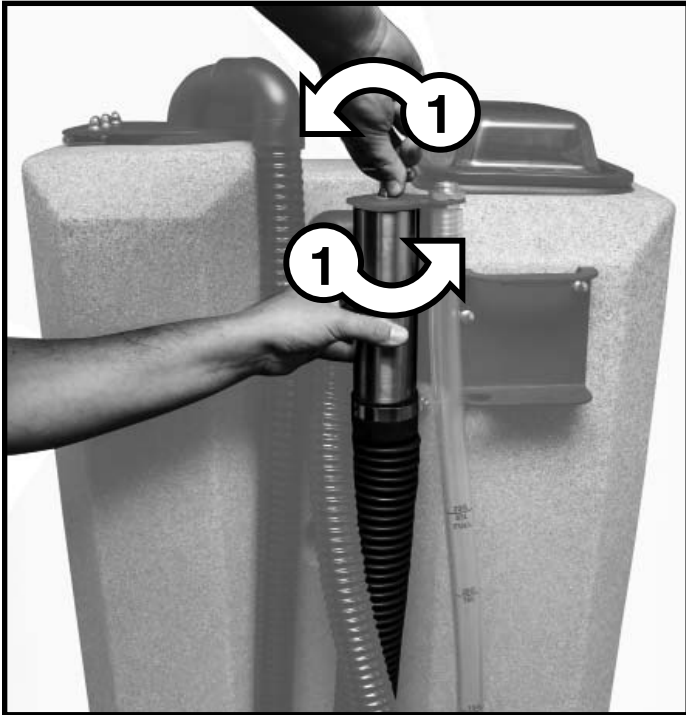

# DRAINING SOLUTION TANK

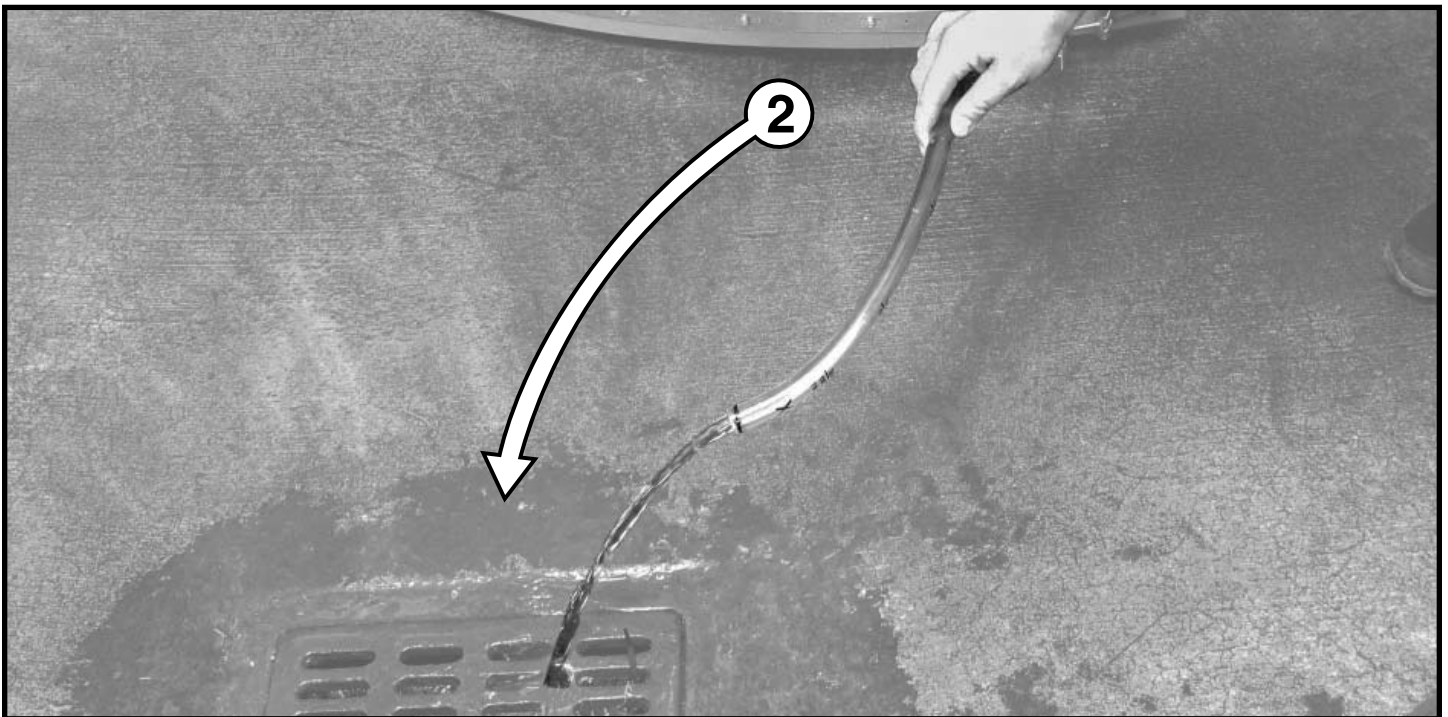
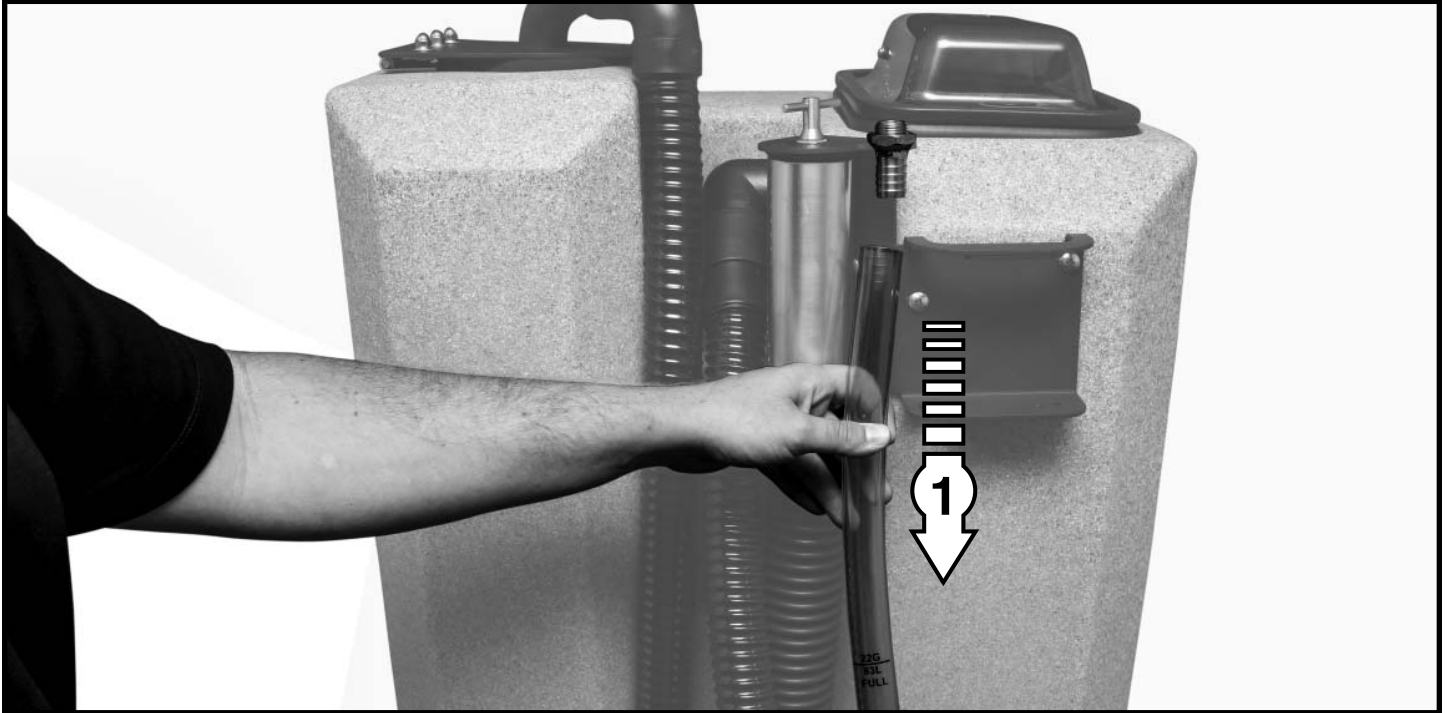

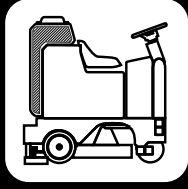

## FLUSHING RECOVERY TANK

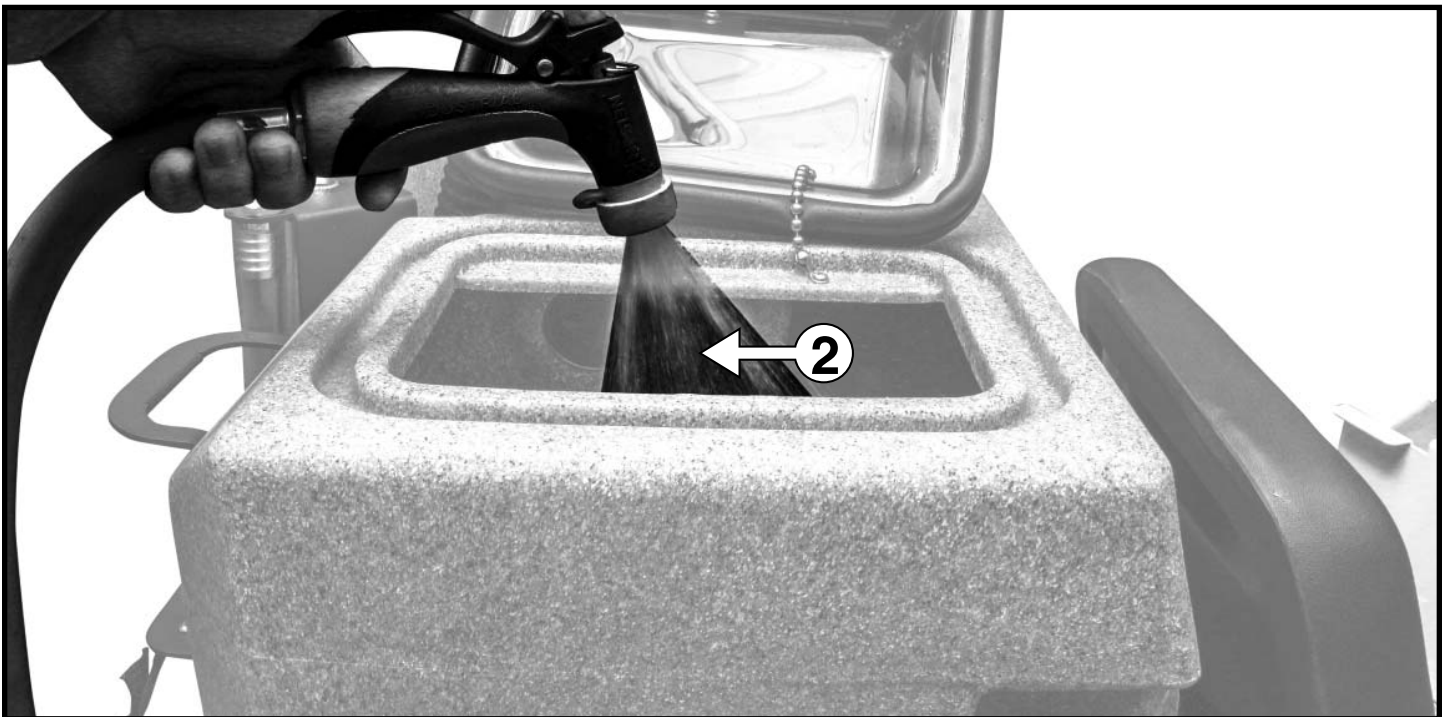

CLEAN DRAIN SAVER

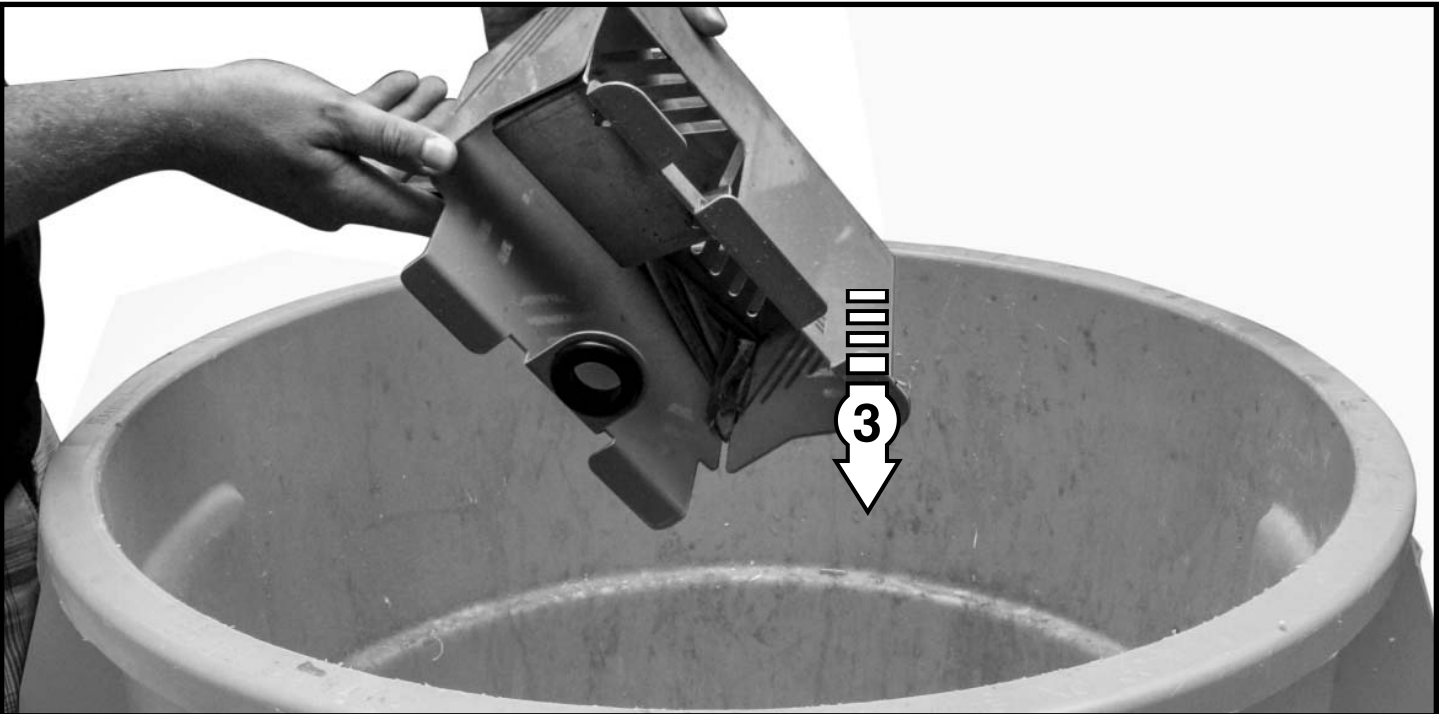



## CLEAN CYLINDRICAL HOPPER

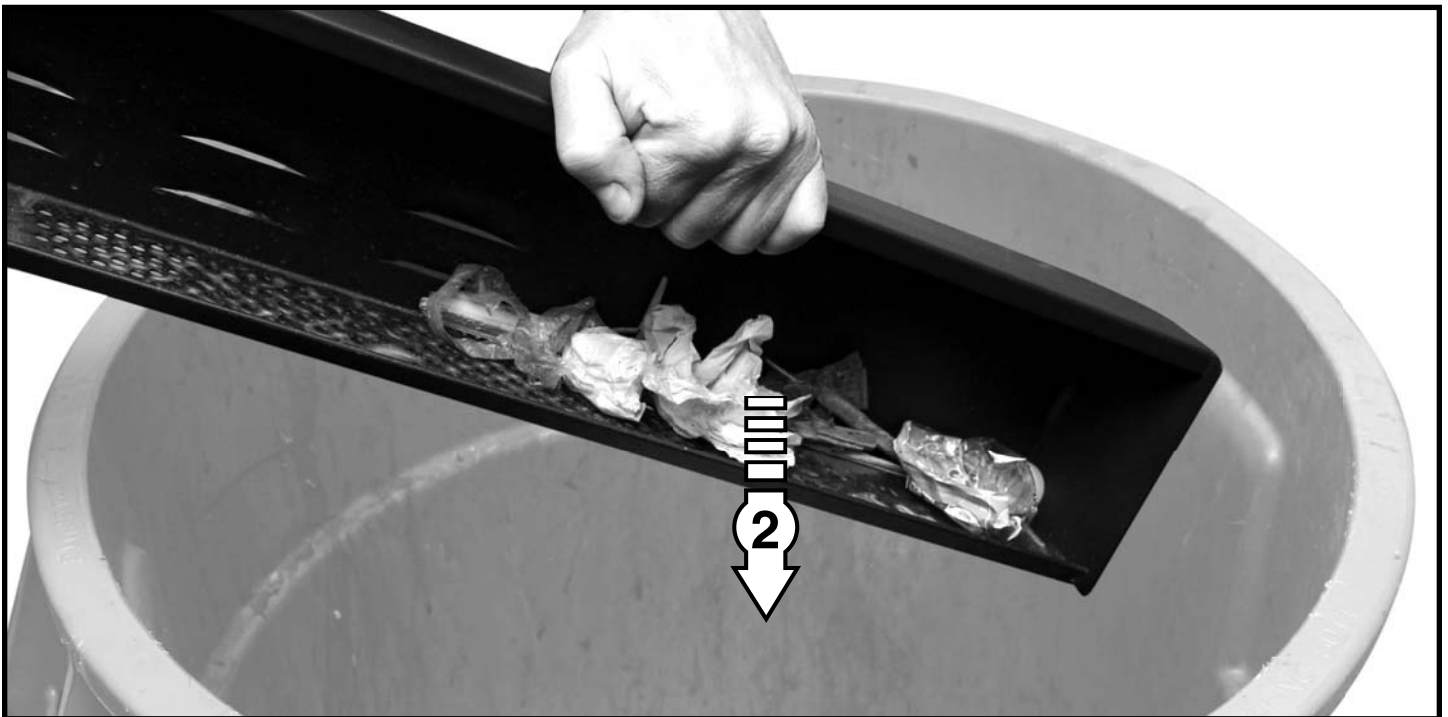
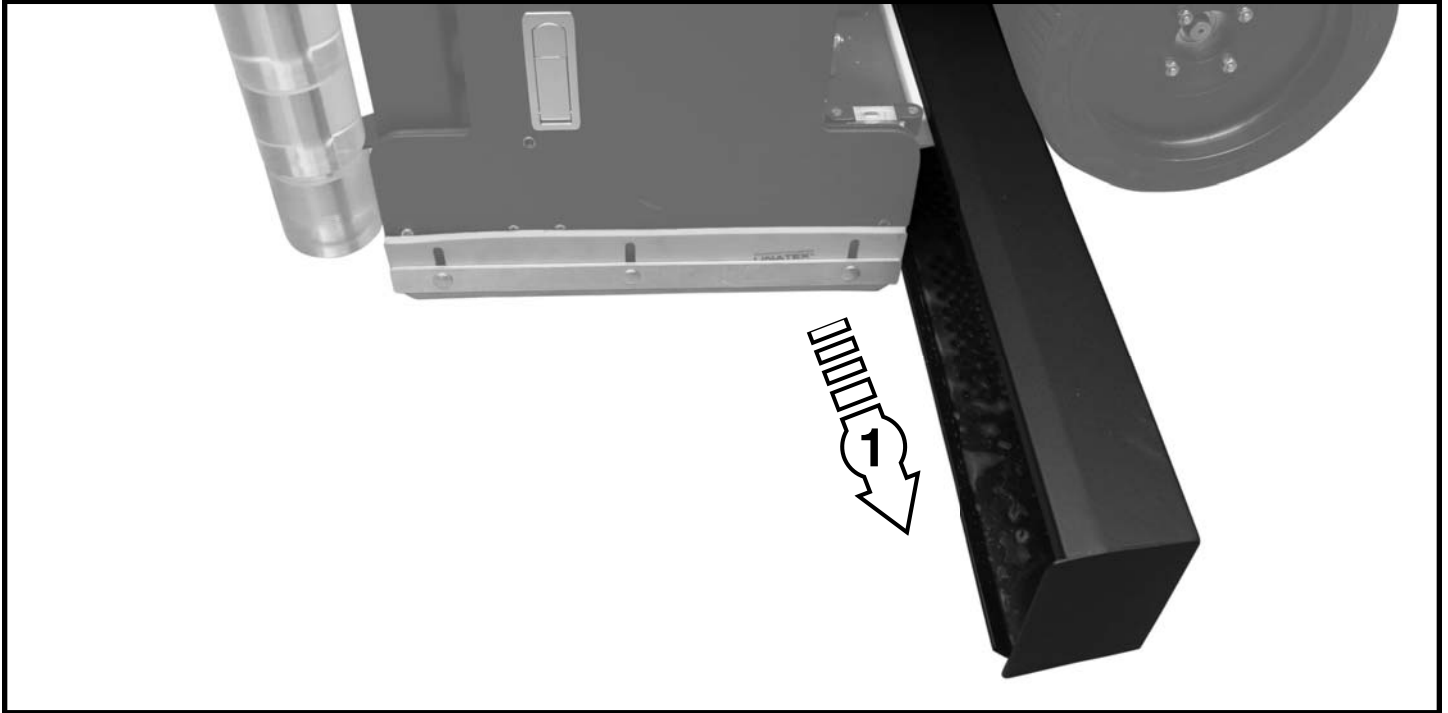

# CLEAN VAC BOX SYSTEM

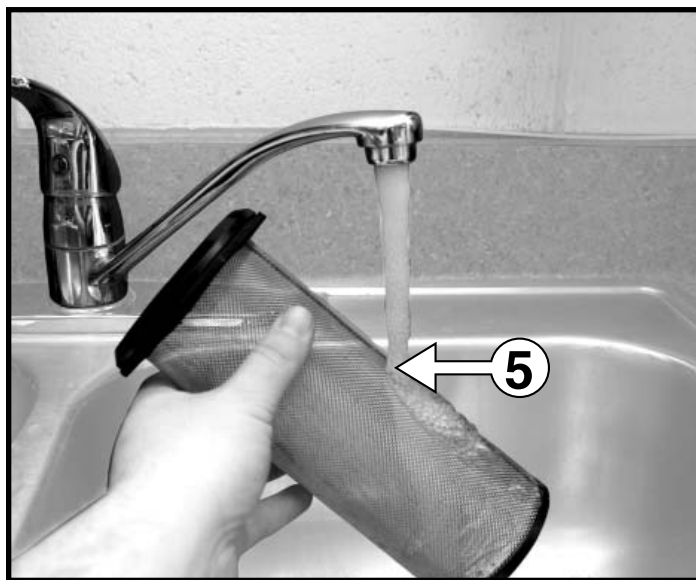
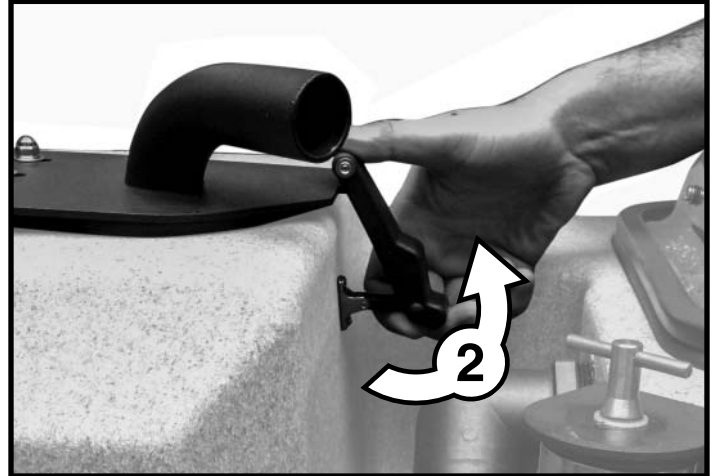

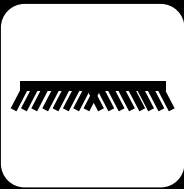

# REMOVE DISK BRUSHES

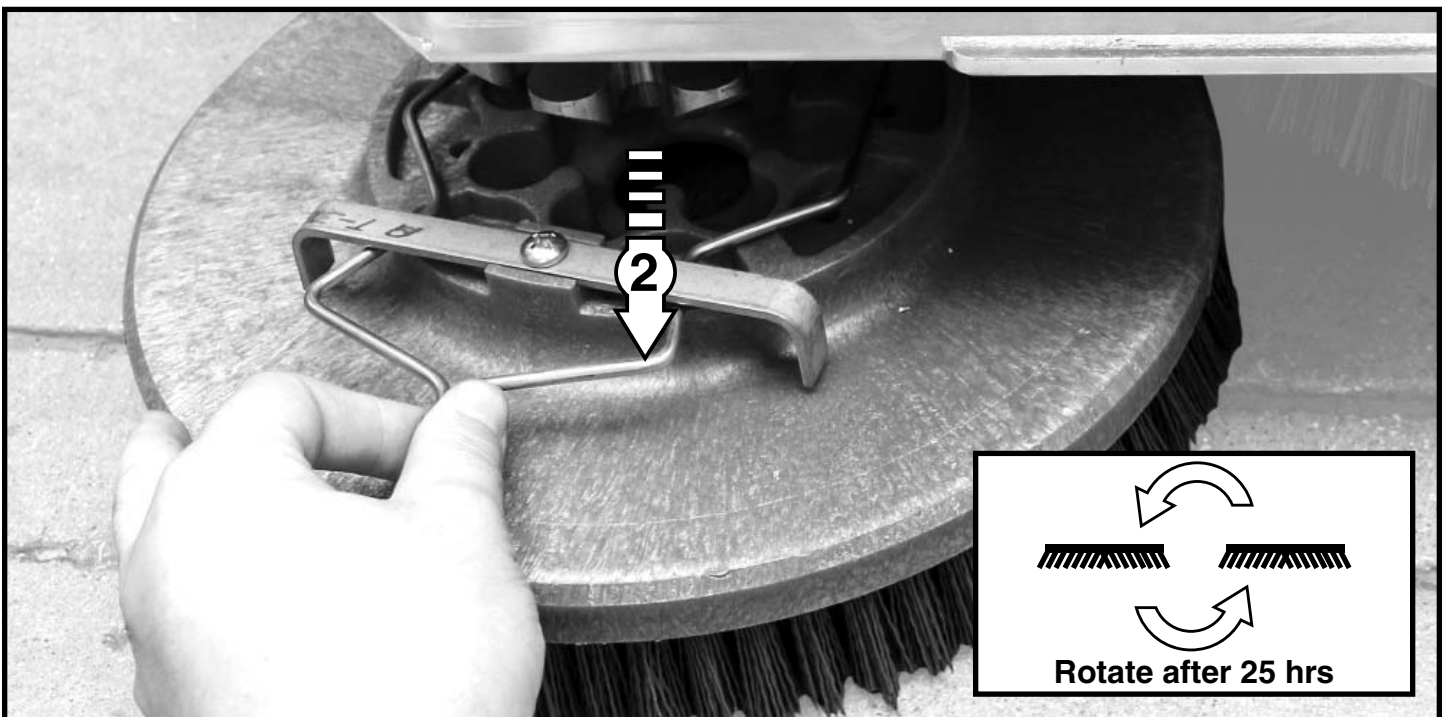



# REMOVE CYLINDRICAL BRUSHES

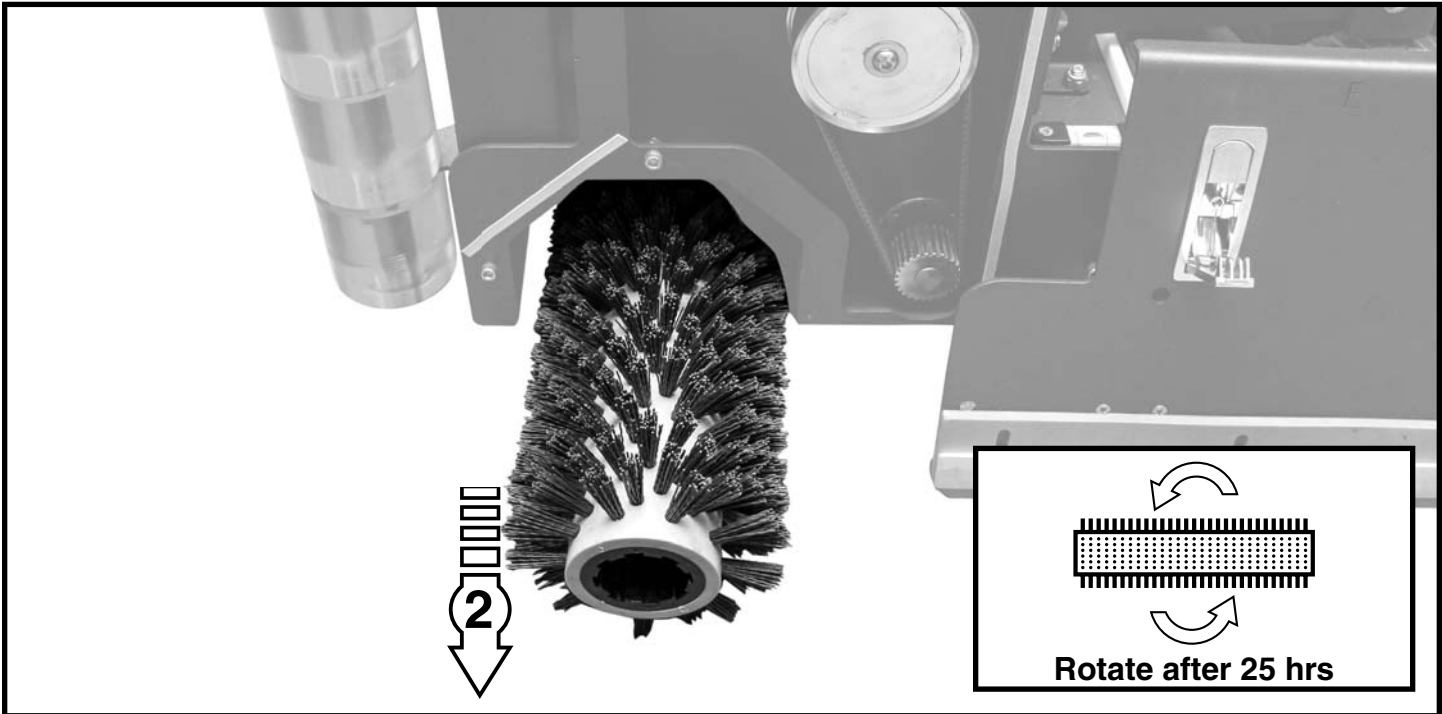
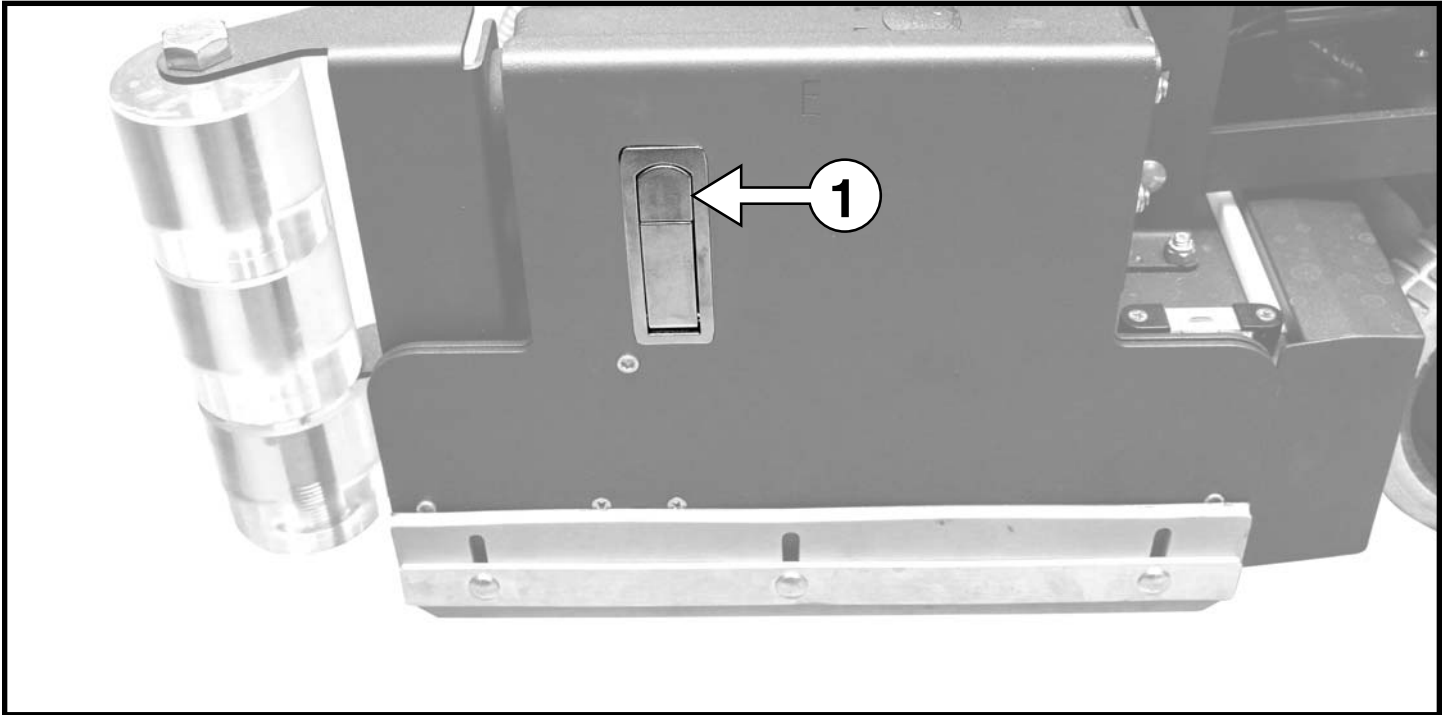
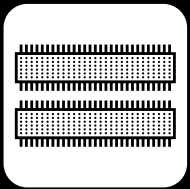

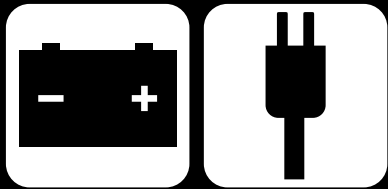

## CHARGE BATTERIES



Please refer to OEM Charger Operating Instructions for more information.

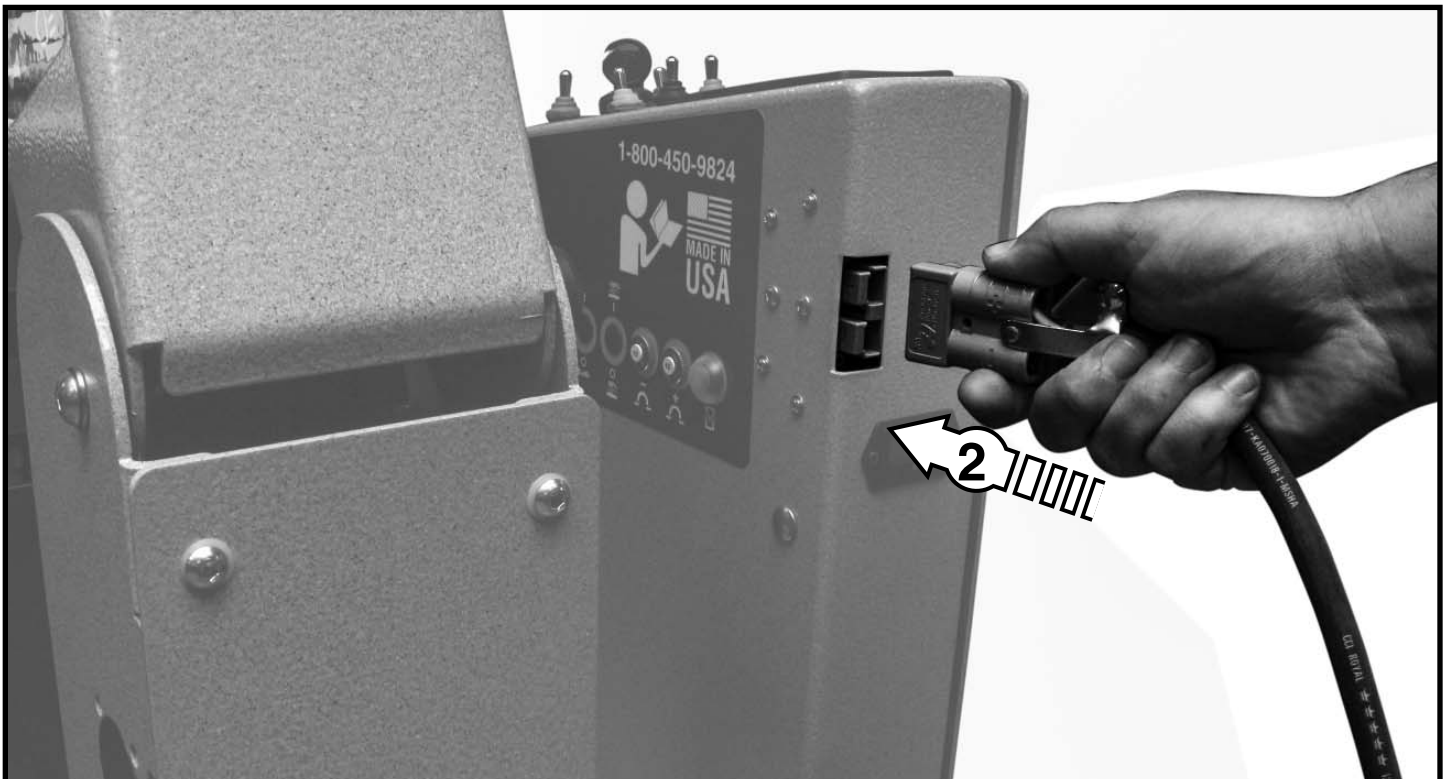

## BATTERY CHARGERS

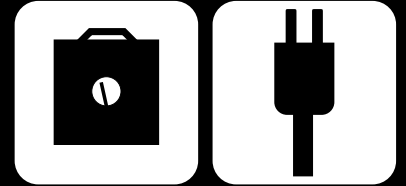

### Console / WET / Domestic Chargers:



**AC Power IN:** 120VAC / 60Hz  
**DC Power OUT:** 36VDC / 25A

Please refer to OEM Charger Operating Instructions for more information.



## COMMON WEAR PARTS

### ROUND DISK BRUSHES:

#### NOTICE

The ## in Disk Column Denotes Desk Pad Size: 13" or 14"

BRUSHES	DISK	LEVEL
Super Grit	##-382SS	Very High
Tough Grit	##-382S	High
Midi Grit	##-382C	Medium
Light Grit	##-382PS	Moderate
Poly	##-382P	Light
Nylon	##-382N	Light
Tampico	##-382T	Light
Pad Driver	##-382D	
Diamond Driver	##-382DD	

### ROUND DISK PADS:

#### NOTICE

The ## in Disk Column Denotes Desk Pad Size: 13" or 14"

DISK PADS	DISK	LEVEL	COLOR
Super Black	##-422BB	Very High	Black
Black	##-422B	High	Black
Brown	##-422BR	High	Brown
Green	##-422G	Medium	Green
Blue	##-422BL	Moderate	Blue
Red	##-422R	Moderate	Red
White	##-422W	Light	White

### CYLINDRICAL BRUSHES:

BRUSHES	MODEL 25" CYLINDRICAL	LEVEL
Tough Grit	236-697S	High
Midi Grit	236-697C	Medium
Light Grit	236-697PS	Moderate
Nylon	236-697N	Light
Tampico	236-697T	Light

### SQUEEGEE BLADE KITS & COMPLETE SQUEEGEE ASSEMBLIES:

SQUEEGEE SIZE	26" DISK DECKS	28" DISK DECKS	25" CYL. DECKS
36" Squeegee	Standard	Optional	Standard
42" Squeegee	Optional	Standard	Optional

SQUEEGEE SIZE	LINATEX BLADE KIT	GUM RUBBER BLADE KIT	URETHANE BLADE KIT	COMPLETE SQUEEGEE ASSEMBLIES
36" Squeegee	36-770L	36-770G	36-770U	36-7180
42" Squeegee	42-770L	42-770G	42-770U	42-7180

SQUEEGEE MATERIAL:	USED FOR:
LINATEX	Provides best wear and tear resistance. Not designed for use with harsh chemicals.
URETHANE	Provides best resistance when dealing with harsh chemicals, oils, fuels, etc.
GUM	Provides best drying performance on rough/grouted floor types by sealing over irregularities. Short life.

## NOTICE

Squeegee blade kits include (1) Rear Blade, (1) Front Blade, and (2) Caster Wheels with hardware.

## NOTICE

Squeegee Assemblies (complete) listed above all come with Linatex blades.

## NOTICE

Size is stamped into the top of the painted steel squeegee body on all squeegee's.

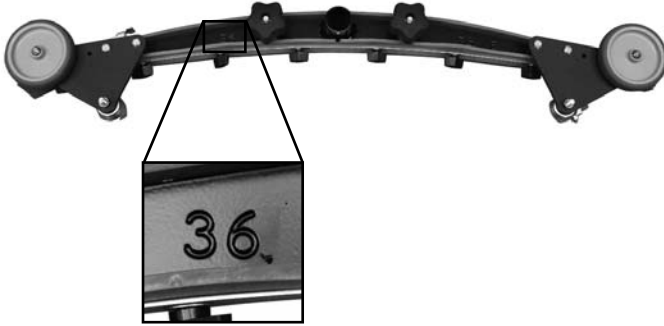

# **BLANK**

THIS PAGE WAS INTENTIONALLY LEFT BLANK

**BLANK**

THIS PAGE WAS INTENTIONALLY LEFT BLANK

**FACTORYCAT**<sup>®</sup>

1711 South Street  
Racine, WI 53404  
[www.factorycat.com](http://www.factorycat.com)  
Tel. US: 800-634-4060  
Tel. Int: (001) 262-681-3583